

### EFCB Series

- EFCB10TU2** (24Vac / 2 relays)
- EFCB10TU4** (24Vac / 4 relays)
- EFCB11TU2** (120Vac / 2 relays)
- EFCB11TU4** (120Vac / 4 relays)
- EFCB12TU2** (240Vac / 2 relays)
- EFCB12TU4** (240Vac / 4 relays)
- TFL54** (Thermostat)
- TFLH54** (Thermostat with humidity)



EFCB Series



TFL54 or TFLH54

### Description

The EFCB Series Networkable Fan Coil Controller and TFL Series LCD Thermostat are designed for simple and accurate control of any fan coil application. The Networkable Fan Coil Controller is mounted inside the fan coil cabinet and incorporates a configurable fan coil algorithm, variable three speed fan control and either modulating or digital heating and cooling outputs. All inputs and high/low voltage outputs are centralized at the control module in the fan coil cabinet.

### Applications

- Compatible with 2 or 4 pipe systems
- Fan coil unit (up to 3 speeds and/or analog 0-10 Vdc)
- Cooling signal (on/off, floating or modulating 0-10 Vdc)
- Heating signal (on/off, floating, pulse or modulating 0-10 Vdc)
- Cool, Heat, Reheat, Reheat with fan, Changeover, Fan, Humidify and Dehumidify by cooling.

### Typical Application

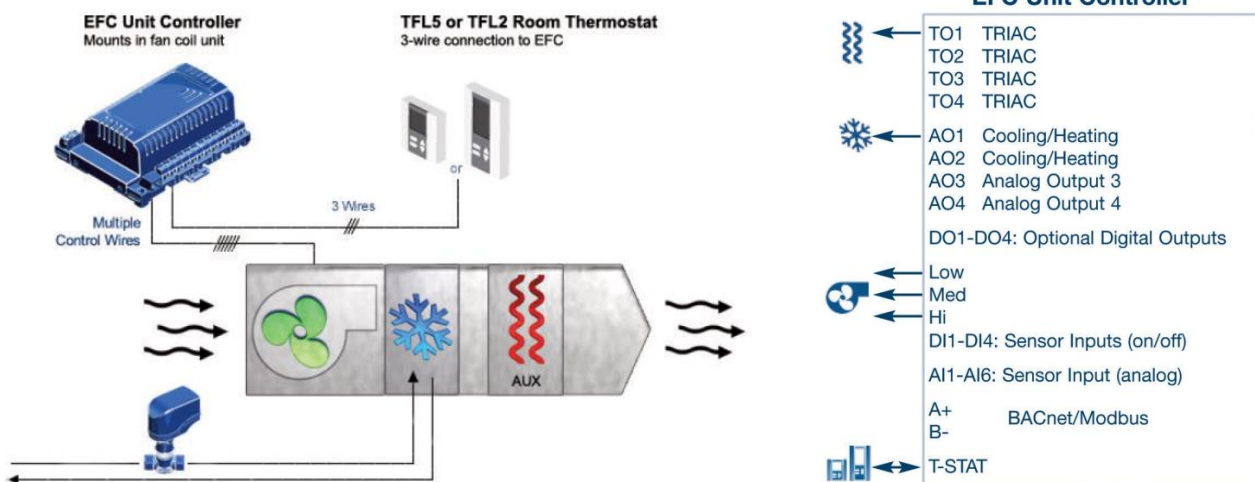

### Features

- Built-in configurable fan coil algorithms
- Up to 10 inputs and 15 outputs (configurable)
- Select direction on digital inputs and all outputs
- Selectable proportional control band and dead band
- Selectable fan speed contacts
- Independent cool/heat setpoint for NSB/OCC mode
- No occupancy and NSB override
- Selectable internal or external temperature sensor (10KΩ)
- Change over by contact or 10KΩ temperature sensor
- Internal and external temperature sensor calibration
- Freeze protection
- Multi level lockable access menu and setpoint
- Removable, raising clamp, non-strip terminals

### Thermostat Features

- Backlit LCD with simple icon and text driven menus
- Select thermostat's default display
- BACnet service port via on-board mini USB connector
- Selectable Fahrenheit or Celsius scale
- 3-wire connection to controller and 4 push buttons

### Network Communication

- BACnet® MS/TP or Modbus communication port
- Select MAC address via DIP switch or via network
- Automatic baud rate detection

### BACnet MS/TP®

- Automatic device instance configuration
- Copy & broadcast configuration via thermostat menu or via BACnet to other controllers
- BACnet scheduler
- Firmware upgradeable via BACnet
- Support COV (change of value)

### Modbus

- Modbus @ 9600, 19200, 38400 or 57600 bps
- RTU Slave, 8 bits (configurable parity and stop bits)
- Connects to any Modbus master



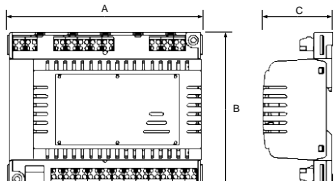



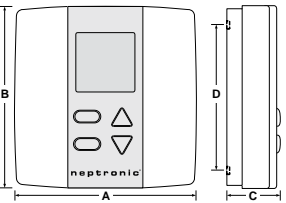

## Controller Specifications

Description	EFCB Series
Inputs	2 fixed analog inputs (external temp. and changeover sensors); 10KΩ or contact 4 analog inputs (0-10 Vdc or 10 KΩ via DIP switches) 3 configurable digital inputs 1 night setback or occupancy sensor input
Outputs	4 analog, 0-10 Vdc configurable outputs (changeover/cooling/heating, fan, humidity) 4 configurable TRIAC outputs (changeover/cooling/heating) 3 speed fan (Motor and/or compressor inductive ratings: ¼ Hp/10 LRA/2.5 FLA 240 Vac Maximum Resistive ratings: 7 Amp/1680 W at 240 Vac Maximum); configurable up to 3 speeds 2 or 4 configurable digital outputs (changeover/cooling/heating, humidity, 3A dry contact)
Power supply	240 Vac
Power consumption	8 VA max. 24 Vac thermal fused.
BACnet	BACnet® MS/TP @ 9600, 19200, 38400 or 76800 bps (BAS-C)
Modbus	Modbus RTU slave @ 9600, 19200, 38400 or 57600. Selectable parity and stop bit configuration: No parity, 2 stop bit Even parity, 1 stop bit Odd parity, 1 stop bit
Communication Connections	24 AWG twisted-shield cable (Belden 9841 or equivalent)
Electrical Connections	0.8 mm <sup>2</sup> [18 AWG] minimum
Operating temperature	0°C to 50°C [32°F to 122°F]
Storage temperature	-30°C to 50°C [-22°F to 122°F]
Relative Humidity	5 to 95% non condensing
Enclosure protection	IP 30 (EN 60529)
Weight	635 g. [1.4 lb]
Dimensions: A = 6.30"   160mm B = 5.00"   126mm C = 2.25"   57mm	

## Thermostat Specifications

Description	TFL54	TFLH54
Sensor	Temperature	Temperature and Humidity
Setpoint range	10°C to 40°C [50°F to 104°F]	10°C to 40°C [50°F to 104°F]   10 to 65%RH
Control accuracy	±0.5°C [0.9°F] @ 22°C [71.6°F] typical calibrated	±0.5°C [0.9°F] @ 22°C [71.6°F]   ±3.5% RH
Display resolution	±0.1°C [0.2°F]	0.1%
Electrical connection	3 wires to EFCB controller and 2 wires (optional) to BACnet network service port 0.8 mm <sup>2</sup> [18 AWG] minimum	
BACnet service port	Mini USB connector	
Power supply	24Vac or 24Vdc	
Power consumption	1VA	
Operating temperature	0°C to 50°C [32°F to 122°F]	
Storage temperature	-30°C to 50°C [-22°F to 122°F]	
Relative humidity	5 to 95 % non condensing	
Enclosure protection	IP 30 (EN 60529)	
Weight	80 g. [0.18 lb]	
Dimensions A = 3.00 in (78mm) B = 3.00 in (78mm) C = 1.00 in (24mm) D = 2.36 in (60mm)		
<b>Note</b>	The TFL thermostat functions only with the EFCB controller. All the inputs/outputs are located on the EFCB except for the temperature/humidity sensor built-in the TFL.	

## Interface

	 <b>Cooling ON</b> <i>A: Automatic</i>	 <b>Programming mode</b> <i>(Technician setting)</i>	 <b>Alarm status</b>
	 <b>Heating ON</b> <i>A: Automatic</i>	 <b>Menu set-up Lock</b>	 <b>Energy saving mode</b>
	 <b>Fan ON</b> <i>3rd speed activated</i> <i>A: Automatic</i>	<b>MIN</b> <b>MAX</b>	<b>Minimum/Maximum</b>

## Mounting Instructions

**⚠ CAUTION: Remove power to avoid a risk of malfunction.**

- Remove the captive screw that's holding the base and the front cover of the unit together.
- Lift the front cover of the unit to separate it from the base.
- Pull all wires through the holes in the base.
- Secure the base to the wall using wall anchors and screws (supplied). Make the appropriate connections.
- Mount the control module on the base and secure using the screw.

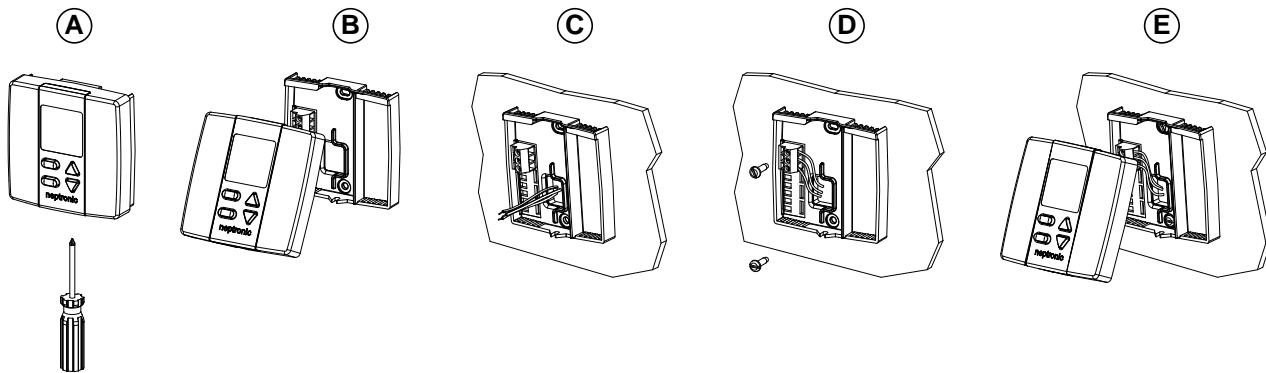

## BACnet or Modbus Address DIP Switch (DS2)

MAC address for communication, are selectable by DIP switch using binary logic. If you do not change device instance in program mode, it will be automatically modified according to the MAC address.

**i** Note: Avoid using addresses above 246 when selecting Modbus MAC address.

MAC Address	DS.1 = 1	DS.2 = 2	DS.3 = 4	DS.4 = 8	DS.5 = 16	DS.6 = 32	DS.7 = 64	DS.8 = 128	Default Device Instance
0	OFF	OFF	OFF	OFF	OFF	OFF	OFF	OFF	153000
1	ON	OFF	OFF	OFF	OFF	OFF	OFF	OFF	153001
2	OFF	ON	OFF	OFF	OFF	OFF	OFF	OFF	153002
3	ON	ON	OFF	OFF	OFF	OFF	OFF	OFF	153003
4	OFF	OFF	ON	OFF	OFF	OFF	OFF	OFF	153004
...	...	...	...	...	...	...	...	...	...
126	OFF	ON	ON	ON	ON	ON	ON	OFF	153126
127	ON	ON	ON	ON	ON	ON	ON	OFF	153127

\* Slave addresses available by setting DS.8 to ON



### Wiring

We strongly recommend that all Neptronic products be wired to a separate grounded transformer and that transformer shall service only Neptronic products. This precaution will prevent interference with, and/or possible damage to incompatible equipment.

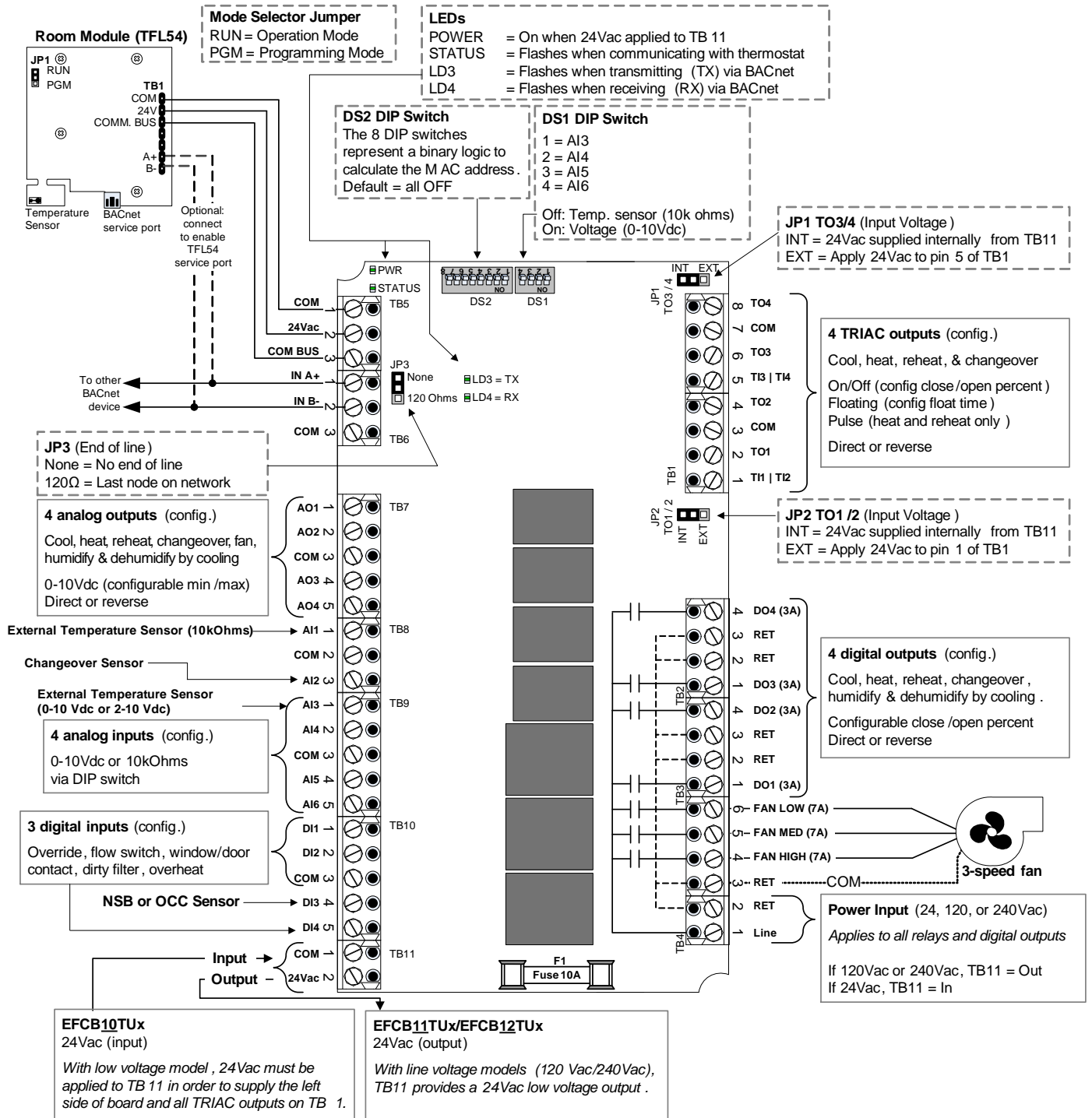

### Analog Inputs – Menu Overview (1 of 8) | AI2 to AI6

Main Menu	Sub Menu	Configuration
-----------	----------	---------------

\*\*\* You must press the **↵** button to save any changes \*\*\*  
 \*\*\* Pressing the **⏪** button returns to the previous step without saving \*\*\*

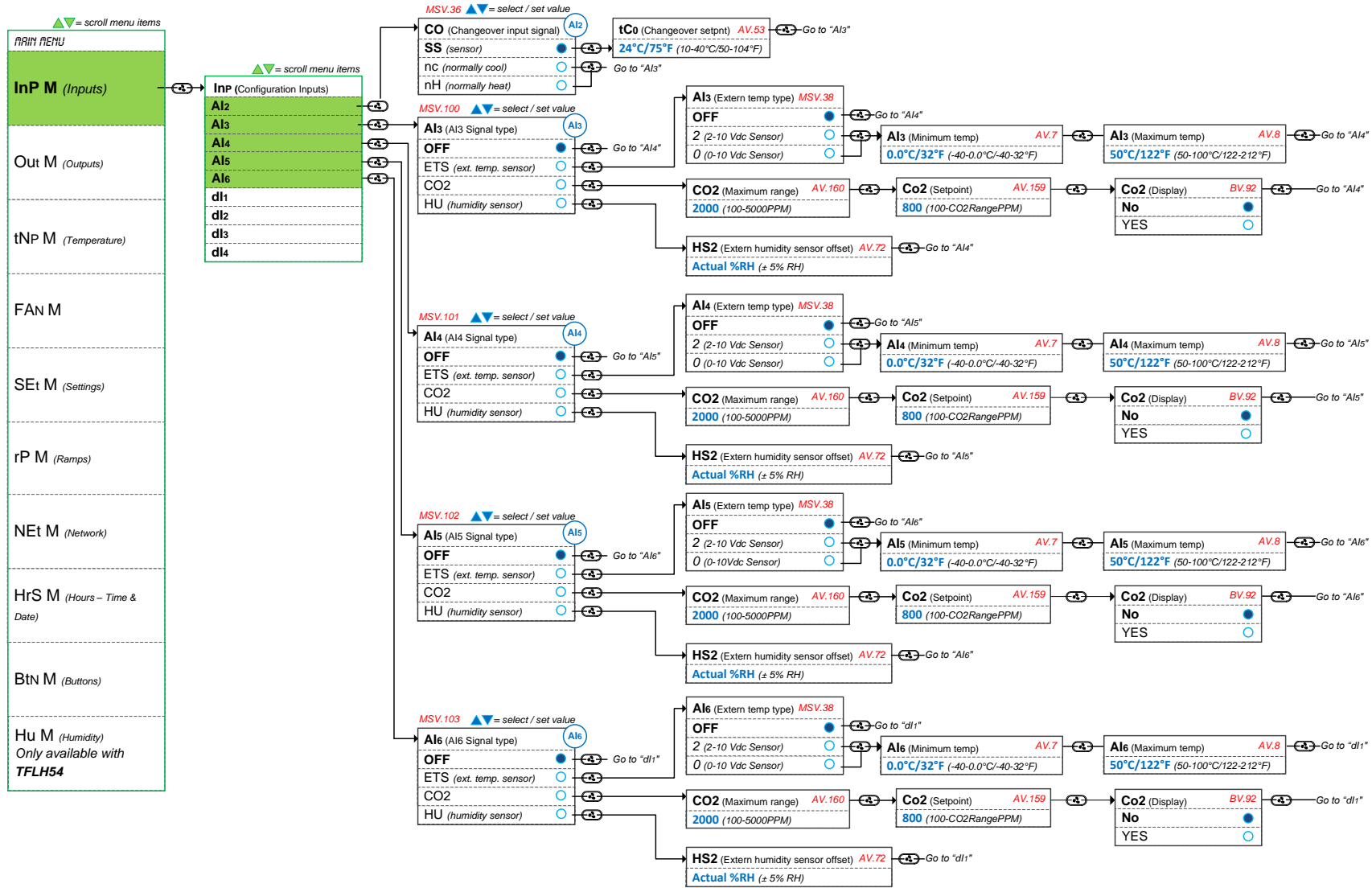



### Digital Inputs – Menu Overview (2 of 8) | DI1 to DI4

Main Menu	Sub Menu	Configuration
-----------	----------	---------------

\*\*\* You must press the **↵** button to save any changes \*\*\*

\*\*\* Pressing the **⏪** button returns to the previous step without saving \*\*\*

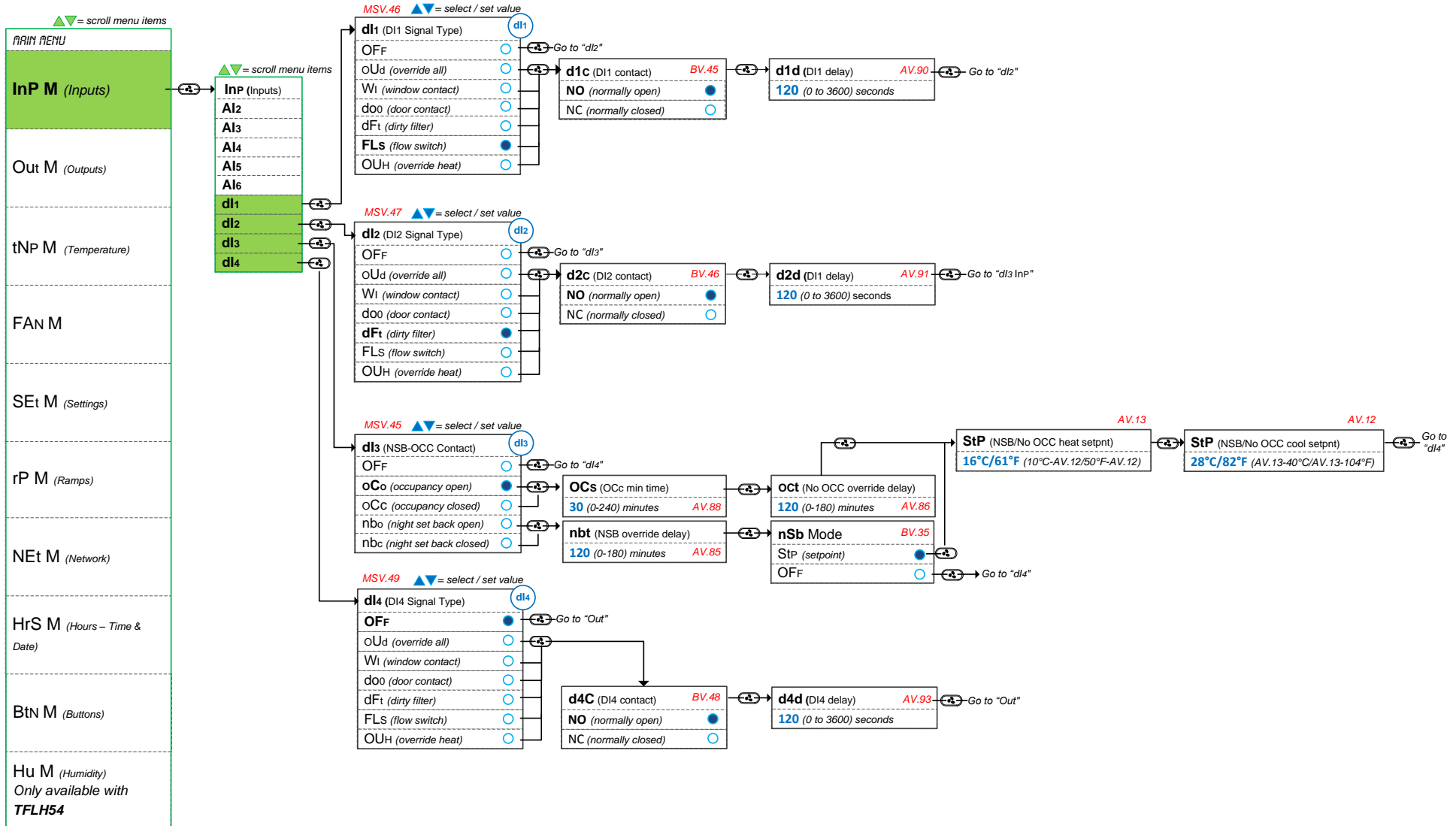

### TRIAC Outputs – Menu Overview (3 of 8) | TO1 to TO4

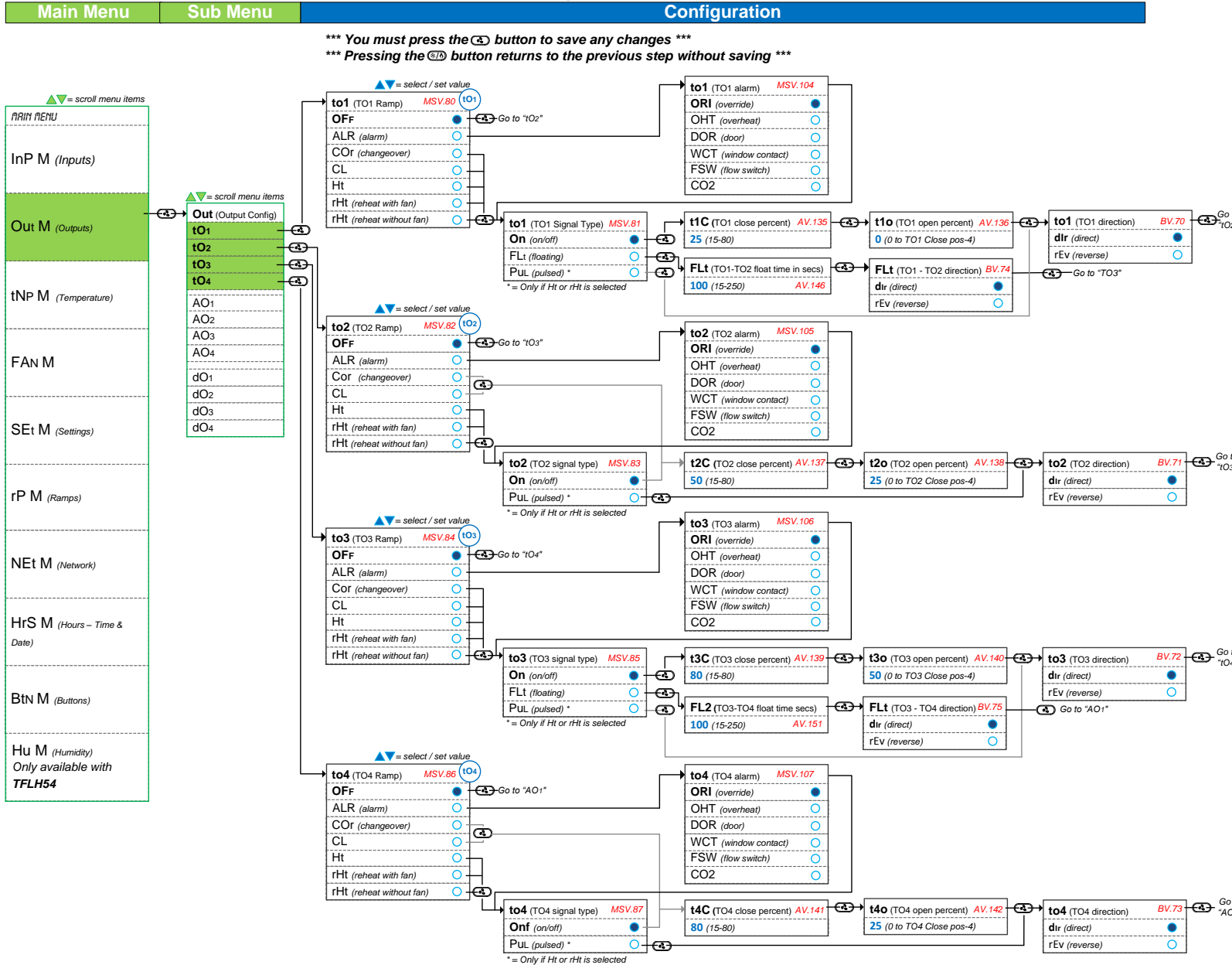

### Analog Outputs – Menu Overview (4 of 8) | AO1 to AO4

Main Menu	Sub Menu	Configuration
-----------	----------	---------------

\*\*\* You must press the **↵** button to save any changes \*\*\*  
 \*\*\* Pressing the **⏪** button returns to the previous step without saving \*\*\*

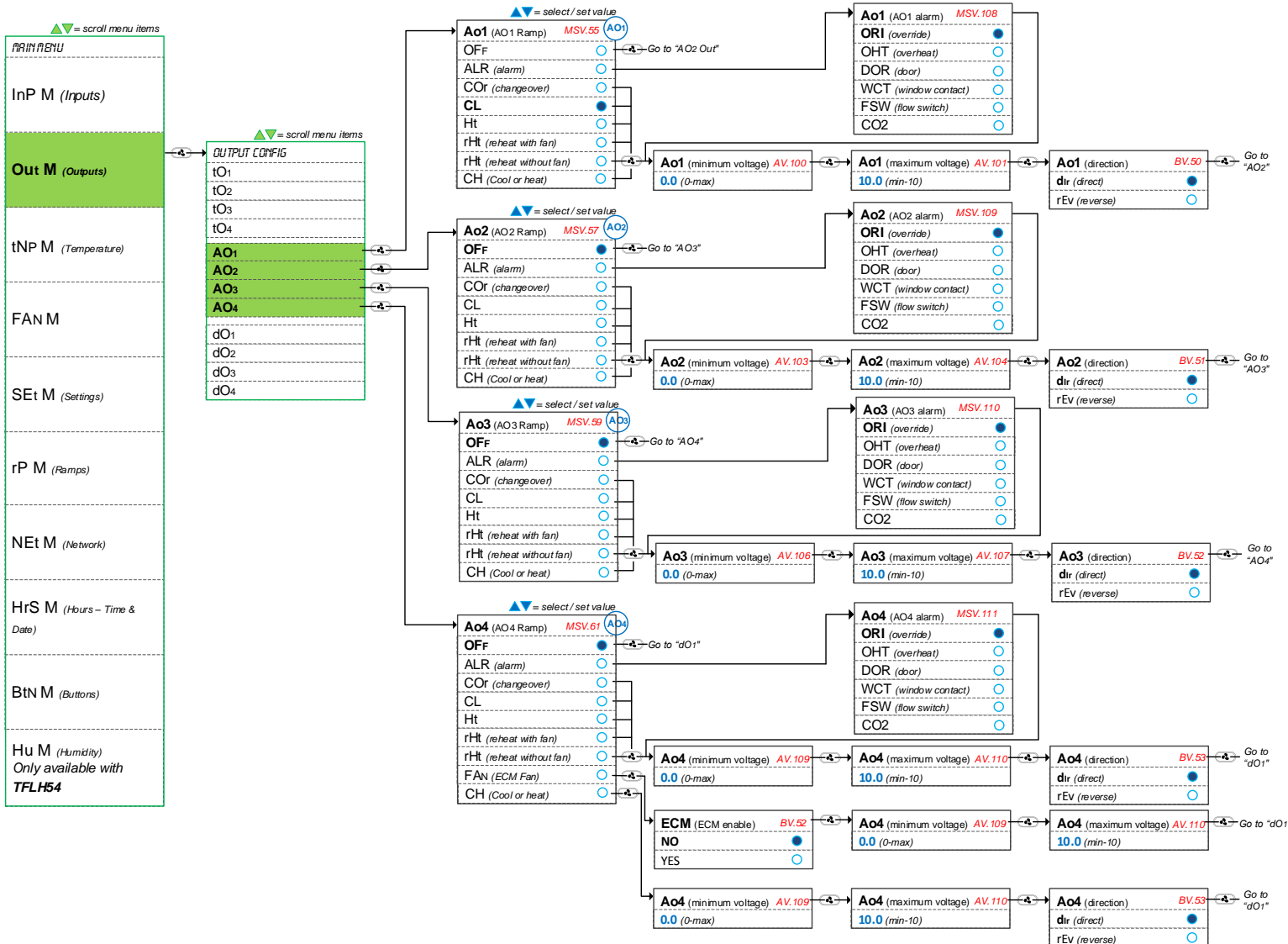



### Digital Outputs – Menu Overview (5 of 8) | DO1 to DO4

Main Menu	Sub Menu	Configuration
-----------	----------	---------------

\*\*\* You must press the **↵** button to save any changes \*\*\*

\*\*\* Pressing the **⏪** button returns to the previous step without saving \*\*\*

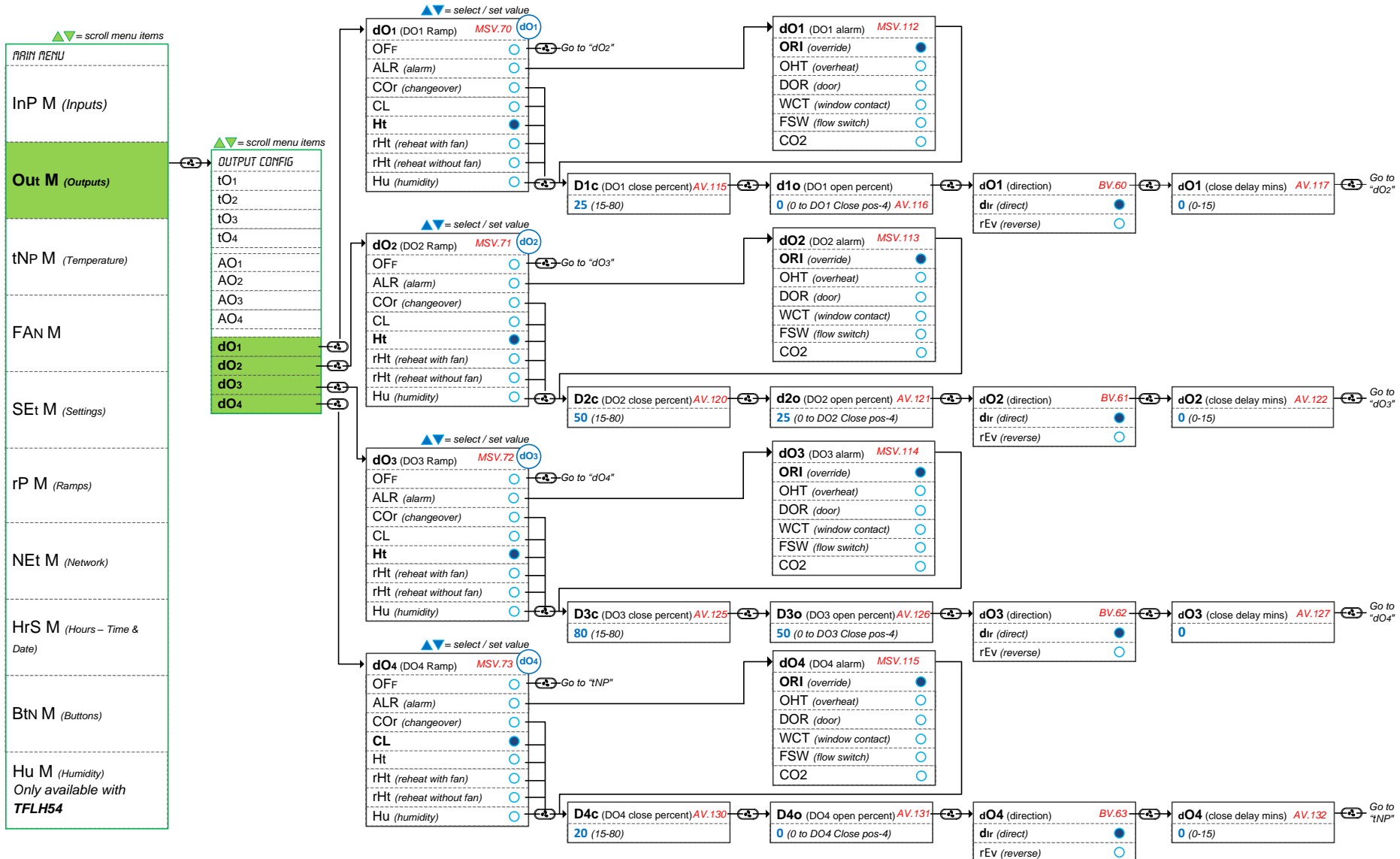

### Settings – Menu Overview (6 of 8) | Temp, Fan, Settings and Ramps

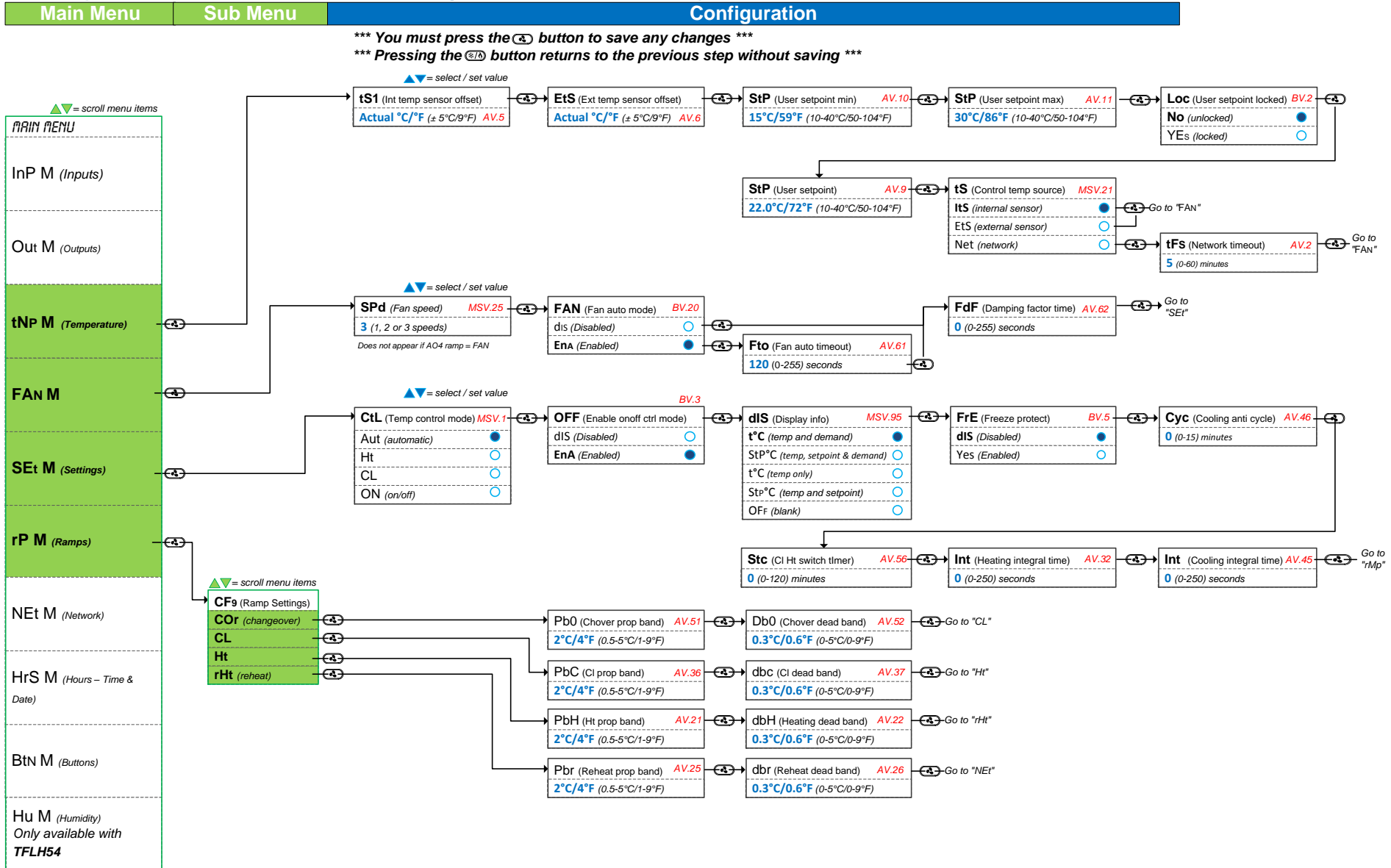

### Network and Calendar – Menu Overview (7 of 8) | Network, Time and Buttons



\*\*\* You must press the **↵** button to save any changes \*\*\*  
 \*\*\* Pressing the **⏪** button returns to the previous step without saving \*\*\*

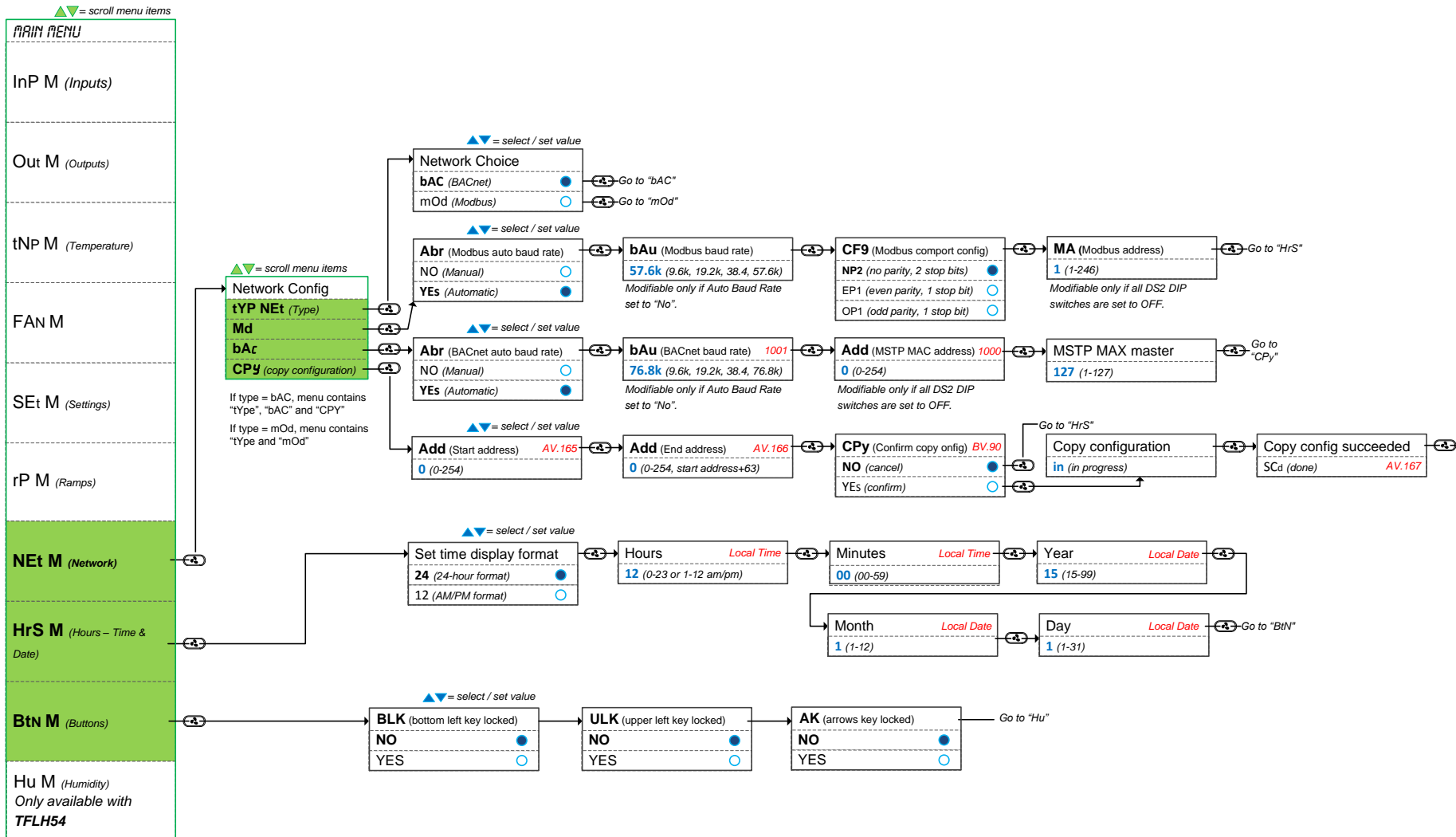

### Humidity – Menu Overview (8 of 8) | Humidity

Only available when a humidity sensor thermostat is connected to the controller.

Main Menu	Sub Menu	Configuration
-----------	----------	---------------

\*\*\* You must press the **↵** button to save any changes \*\*\*  
 \*\*\* Pressing the **⏪** button returns to the previous step without saving \*\*\*  
 \*\*\* The Hu (Humidity) menu is available only on TFLH54 \*\*\*

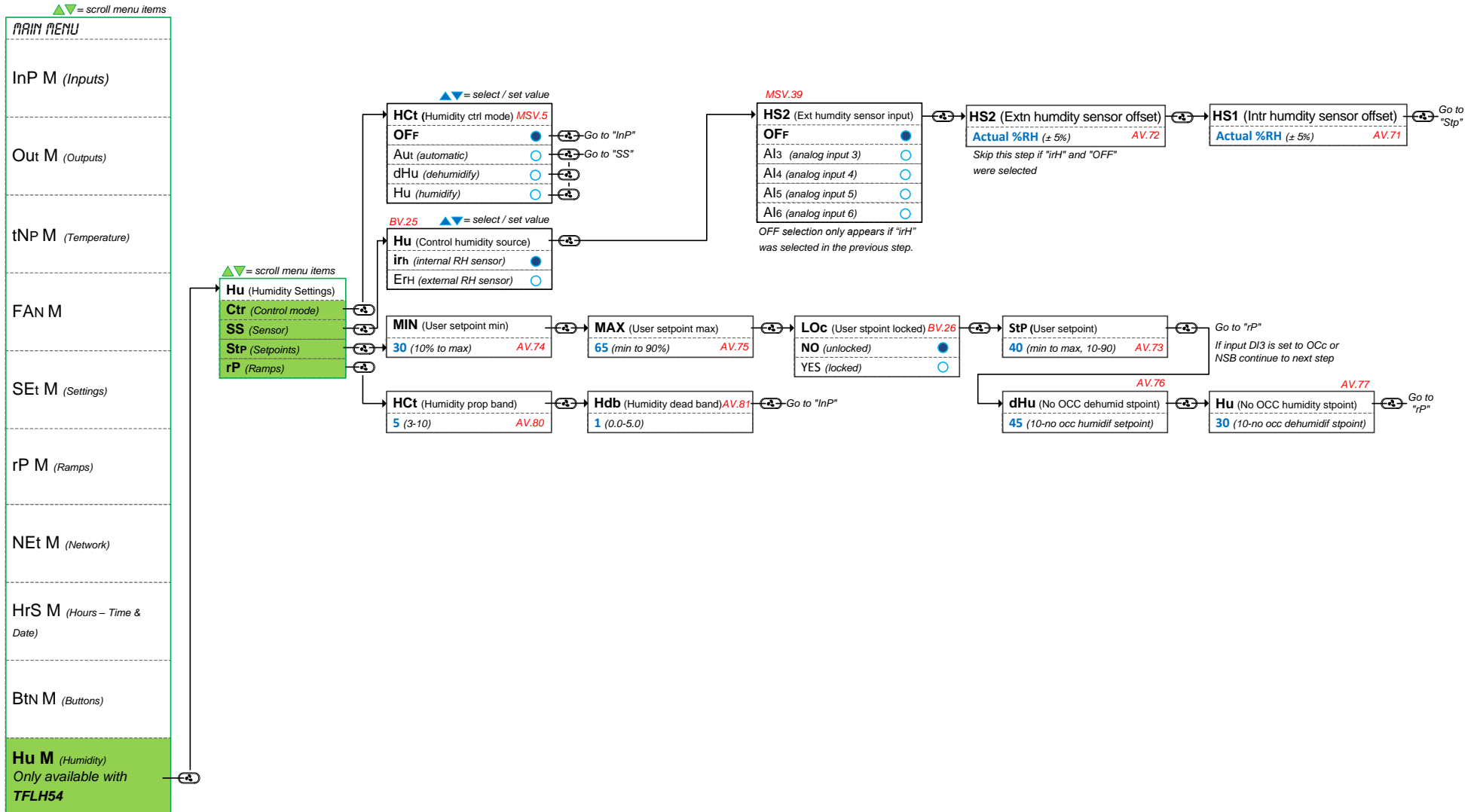

## Operation Menus

This menu is accessible through normal operation mode.

- The Mode Selector jumper (JP1) of the thermostat must be set to the "RUN" position (Operation Mode). Refer to Wiring on page 4.
- Press the and buttons simultaneously for 5 seconds. "PR5" appears on the screen.
- Enter the password within 1 minute by using the arrow keys to increase or decrease the value and the and buttons to toggle between the digits.
  - Password **372** = Sensor Offset Menu
  - Password **637** = Network Settings Menu
- If you enter the wrong password, the thermostat displays "Err" and returns to Operation Mode. The thermostat will return to normal mode if you navigate through the entire menu and do not make any selection, or if you do not press any key for 5 minutes. The changed values will be saved automatically.

### Menu 372 – Sensor Offset

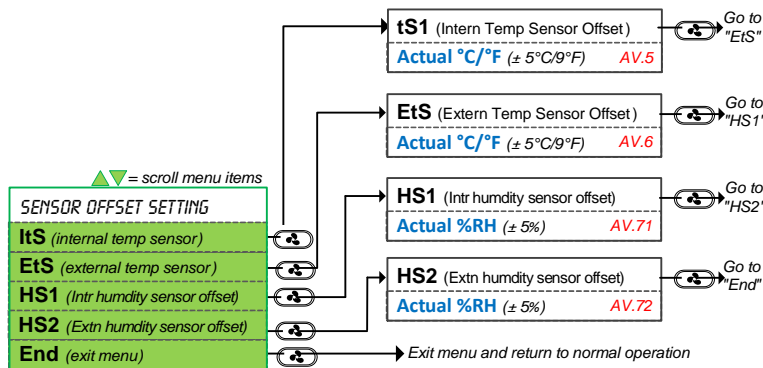

\*\*\* You must press the button to save any changes \*\*\*

\*\*\* Pressing the button returns to the previous step without saving \*\*\*

### Menu 637 – Network Settings

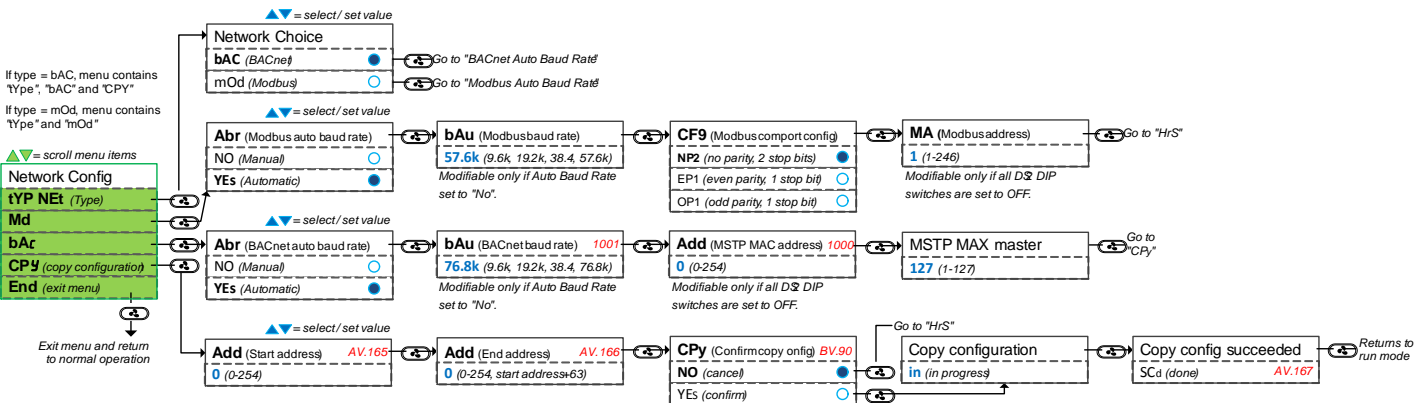

\*\*\* You must press the button to save any changes\*\*\*

\*\*\* Pressing the button returns to the previous step without saving\*\*\*

## Reset to Factory Default Settings



This will erase all actual configurations and replace them with the factory default settings.

- The Mode Selector jumper (JP1) of the thermostat must be set to the "RUN" position (Operation Mode). Refer to Wiring on page 4.
- During the power up sequence of the controller and thermostat, press and hold both the and buttons.
- The "ENTER PASSWORD" screen appears. Enter **372** within 1 minute by using the arrow keys to increase or decrease the value and the and buttons to toggle between the digits.
- Use the arrow buttons to select YES and then press .

## Operation Mode

The Mode Selector Jumper of the thermostat must be set to the "RUN" position (Operation Mode). Refer to Wiring on page 4.

## Power Up

Upon power up, the LCD illuminates and all segments appear for 2 seconds. The thermostat then displays its current version of the thermostat for 2 seconds followed by the current version of the controller for 2 seconds. Pressing any key on the thermostat illuminates the LCD for 4 seconds.

## Temperature Display and Setpoint



The thermostat displays the temperature reading. If the sensor is disconnected or short circuited, the unit displays the sensor's limits. To toggle the temperature scale between °C and °F, press both the ▲ and ▼ keys for 3 seconds. To display the setpoint, press the ▲ and ▼ key twice. The set point appears for 5 seconds. To adjust the setpoint, press the arrow keys while the temperature is displayed. If the setpoint adjustment has been locked, the lock  symbol appears.

## Temperature and Humidity (TFLH54 thermostats only)

The thermostat displays the temperature reading for 8 seconds and then displays the humidity reading for 2 seconds. If the sensor is disconnected or short circuited, the unit displays the sensor's limits. To toggle the temperature scale between °C and °F, press both the ▲ and ▼ keys for 3 seconds.



To access the Humidity setpoint, press the  button for 5 seconds. The humidity setpoint will be displayed for 5 seconds. To adjust the setpoint, press the ▲ and ▼ keys while the setpoint is displayed. The unit will return to normal mode if you do not press any key for 3 seconds. The changed values will be saved automatically.

## Control Mode

To access the Control Mode, press the  key. The Control Mode appears for 5 seconds. Press the  key to scroll through the following control modes. These options can vary depending on the options selected.



- Auto (Automatic Cooling or Heating)
- Cooling only (on, with cooling symbol)
- Heating only (on, with heating symbol)
- OFF (if it is not disabled in Programming Mode)

## Fan Speed Selection Mode

To access the Fan Speed selection mode, press the  key. The mode appears for 5 seconds. These options can vary depending on the fan speed signal and auto mode settings. If in No Occupancy mode, the  button now serves as the override button.

- Automatic speed. Available only if enabled in program mode.
- Low speed
- Medium speed
- High speed
- Off. Off is not selectable by the user, it appears only if the "Control Mode" is "Off" and it indicates that the user can not change the speed of the fan.





## Night Setback (NSB)

This function is only available if you've set DI3 to **nSb** (Night setback contact) If the DI3 contact is triggered, the thermostat enters NSB Mode (the  symbol appears) and uses the NSB setpoints defined in program mode. Press any key to override NSB for the delay defined in program mode (default: 120 minutes). The  symbol flashes to indicate that the NSB mode is overridden (during this time the standard set points are used).

If the NSB Mode was set to OFF, all outputs will be off for the duration of the period and cannot be overridden.

## Occupancy Mode

This function is only available if you've set DI3 to **Occ** (occupancy mode). If the DI3 contact is triggered, the thermostat enters Occupancy Mode (the  symbol appears) and uses the NoOcc setpoints defined in program mode.

If not locked, no occupancy mode can be overridden for a period by pressing the  button. Each time you press the  button, 15 minutes are added to the override (up to a maximum defined in program mode). Press the fan  button until "0" is displayed to disable the override. The  icon will flash and the remaining override time will be displayed in minutes.







Recycling at end of life: please return this product to your Neptronic local distributor for recycling. If you need to find the nearest Neptronic authorized distributor, please consult [www.neptronic.com](http://www.neptronic.com).



**neptronic®**

400 Lebeau blvd, Montreal, Qc, H4N 1R6, Canada

[www.neptronic.com](http://www.neptronic.com)

Toll free in North America: 1-800-361-2308

Tel.: (514) 333-1433

Fax: (514) 333-3163

Customer service fax: (514) 333-1091

Monday to Friday: 8:00am to 5:00pm (Eastern time)