

### Controller Models

<b>EVCB14NIT0S</b>	<i>(0 TRIACS / pressure independent)</i>
<b>EVCB14NIT2S</b>	<i>(2 TRIACS / pressure independent)</i>
<b>EVCB14NIT4S</b>	<i>(4 TRIACS / pressure independent)</i>
<b>EVCB14NDT4S</b>	<i>(4 TRIACS / pressure dependent)</i>
<b>EVCB14NIT0SF</b>	<i>(0 TRIACS / independent / feedback)</i>
<b>EVCB14NIT4SF</b>	<i>(4 TRIACS / independent / feedback)</i>

### TRL Series Digital Room Sensor

<b>TRL24</b>	<i>(With temperature sensor)</i>
<b>TRLH24</b>	<i>(With temperature and humidity sensor)</i>
<b>TRLG24</b>	<i>(With temperature and CO<sub>2</sub> sensor)</i>
<b>TRLGH24</b>	<i>(With temperature, CO<sub>2</sub> and humidity sensors)</i>

### TDU Series Digital Room Sensor

<b>TDU00</b>	<i>(Vertical Grey LCD, white enclosure)</i>
<b>TDU30</b>	<i>(Vertical Black LCD, black enclosure)</i>
<b>TDU60</b>	<i>(Vertical Black LCD, white enclosure)</i>
<b>TDU10</b>	<i>(Horizontal Grey LCD, white enclosure)</i>
<b>TDU40</b>	<i>(Horizontal Black LCD, black enclosure)</i>
<b>TDU70</b>	<i>(Horizontal Black LCD, white enclosure)</i>

### Description

The EVCB Series is a combination controller and digital room sensor with support for networked communications via the BACnet MS/TP or Modbus protocol. The EVCB Series controller is compatible with both TRL24 and TDU series digital room sensors. The Networkable VAV Controller is designed for simple and accurate control of any variable air volume box in a number of zone control configurations. Its field configurable algorithms enable versatile implementation of required control sequences.

### Features

- Field configured VAV algorithms, inputs and outputs
- Built-in actuator, 70 lb-in
- On board differential pressure sensor (select models)
- Select direction on analog outputs
- Simple air balancing and commissioning via digital room sensor
- Automatically sets operation mode to pressure dependent or independent based on the presence of air flow
- Configurable PI (Proportional-Integral) function
- Independent, configurable proportional control band and dead band per ramp
- Selectable internal or external temperature sensor (10KΩ)
- Activate output with CO<sub>2</sub> sensor from TRL/TDU or external sensor input
- Changeover by contact or external temperature sensor
- Internal and external temperature sensor calibration
- Optional potentiometer feedback for increased precision of actuator position
- Freeze protection
- Removable, raising clamp, non-strip terminals

### Operational Features

- Backlit LCD with simple icon and text driven menus
- Select digital room sensor's default display
- Network service port via on-board mini USB connector
- Manual night setback or no occupancy override
- Multi level lockable access menu and setpoint
- Selectable Fahrenheit or Celsius scale
- 3-wire connection to controller and 4 push buttons



EVCB Series



TRL24 Series



TDU00 / TDU30 / TDU60 Series



TDU10 / TDU40 / TDU70 Series

### Applications

- Single duct, cooling only
- Single duct cooling and/or heating
- Up to 4 stage reheat and/or cool
- Up to 4 On/Off heat and/or cool
- Up to 4 time proportioned (TPM) heat or reheat
- Up to 2 analog (0-10Vdc) reheat and/or cool
- Up to 2 floating heat and/or cool
- Pressure dependent or pressure independent
- With or without auto changeover
- Supply/exhaust (requires an additional EVC)

### Network Communication

- BACnet MS/TP or Modbus communication port
- Select MAC address via DIP switch or via network
- Automatic baud rate detection

### BACnet MS/TP®

- Automatic device instance configuration
- Copy & broadcast configuration via digital room sensor menu or via BACnet to other controllers
- BACnet scheduler
- Firmware upgradeable via BACnet
- Support COV (change of value)

### Modbus

- Modbus @ 9600, 19200, 38400 or 57600 bps
- RTU Slave, 8 bits (configurable parity and stop bits)
- Connects to any Modbus master



### Controller Specifications

Description	EVCB Series
Torque	70 in.lb. [8 Nm] at rated voltage
Power consumption	10 VA max
Running time through 90°	90 seconds
Power supply	22 to 26 Vac 50/60 Hz
Inputs	2 Universal inputs (Thermistor 10KΩ Type 3, digital 24Vac/dry contact, or 0-10Vdc) 2 digital inputs
Outputs	2 analog outputs (0-10 Vdc or 2-10Vdc; selectable) Up to 4 TRIAC outputs 24 Vac, 500mA max thermal fuse in series with each TRIAC output (on/off, pulse, or 2 floating outputs)
Real Time Clock	Real-time clock (RTC) with super capacitor backup (approximately 3 days)
BACnet	BACnet® MS/TP @ 9600, 19200, 38400 or 76800 bps (B-ASC)
Modbus	Modbus RTU slave @ 9600, 19200, 38400 or 57600. Selectable parity and stop bit configuration: No parity, 2 stop bit   Even parity, 1 stop bit   Odd parity, 1 stop bit
Communication connection	Low capacitance, EIA RS-485, 22 or 24 AWG shielded twisted pair multi-strand cables (Belden 9841 or equivalent).
Digital Room Sensor connection	Insulated 3 core multi-strand 22 or 24 AWG cable. Maximum 50ft (15m) between controller and digital room sensor.
Electrical connection	Insulated 2 core 0.8 mm <sup>2</sup> [18 AWG] minimum power cable.
Operating temperature	0°C to 50°C [32°F to 122°F]
Storage temperature	-30°C to 50°C [-22°F to 122°F]
Relative Humidity	5 to 95% non condensing
Weight	1.26 kg. [2.8 lb]



**The actuator performs an auto-stroke on power up. When changing the actuator adjustment screws, cycle power to initiate the auto-stroke.**

#### EVC with a built-in 70 in. lb. Actuator

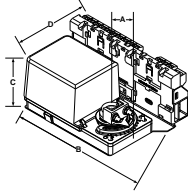

#### Dimensions

- A = 1.50" | 39mm
- B = 7.25" | 185mm
- C = 3.25" | 83mm
- D = 5.50" | 140mm

## Digital Room Sensor Specifications

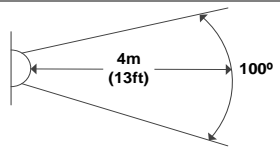
Description	TRL24 and TDU Series
<b>Temperature Sensor (TRL24 and TDU)</b>	
Setpoint range	10°C to 40°C [50°F to 104°F]
Control accuracy	Temperature: ±0.4°C [0.8°F]
Display resolution	±0.1°C [0.2°F]
<b>Humidity Sensor (TRLH24, TRLGH24 and TDU models with Humidity Sensors)</b>	
Sensor range	5 to 95%RH
Display resolution	0.1%
<b>CO<sub>2</sub> Sensor (TRLG24, TRLGH24 and TDU models with CO<sub>2</sub> Sensors)</b>	
Operating principle	Self-calibrating, Non-Dispersive Infrared (NDIR)
Sensor Range	0 to 2000 ppm
Setpoint range	100 to 2000 ppm
Accuracy	±30 ppm ±3% of reading
Response time	2 minutes by 90%
Display resolution	1 ppm
<b>PIR Motion Sensor (TDU00 / TDU 30 / TDU60 models with PIR Sensor)</b>	
Operating Principle	Passive Infrared (PIR)
Detection Angle	100°
Detection Distance	4m [13ft]
Detection Area	
<b>VOC Sensor (TDU00 / TDU30 / TDU60 models with VOC Sensor)</b>	
Operating Principle	Self-calibrating, Non-Dispersive Infrared (NDIR)
Sensor Range	0-1000 ppb isobutylene equivalent tVOCs
Response Time	<5 seconds for tVOC
Start up Time	15 minutes
<b>Other</b>	
Electrical connection	3 wires to VAV controller and 2 wires to BACnet/Modbus network   0.8 mm <sup>2</sup> [18 AWG] minimum
Network service port	Mini USB connector
Power supply	24Vac
Power consumption	1VA
Operating temperature	0°C to 50°C [32°F to 122°F]
Storage temperature	-30°C to 50°C [-22°F to 122°F]
Relative humidity	5 to 95 % non condensing
Enclosure protection	IP 30 (EN 60529)
Weight	120 g. [0.25 lb]

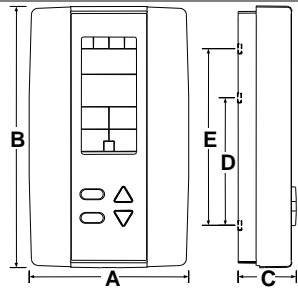
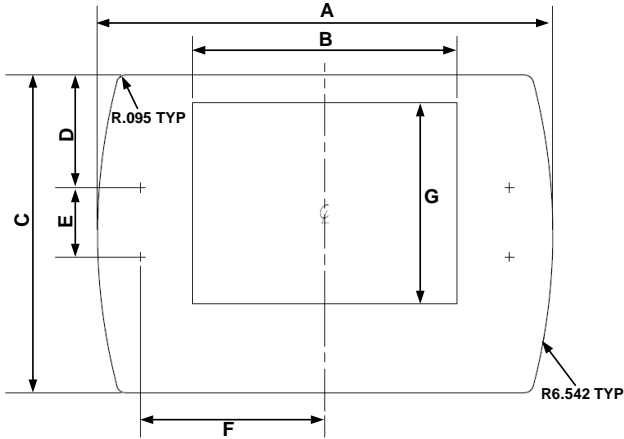
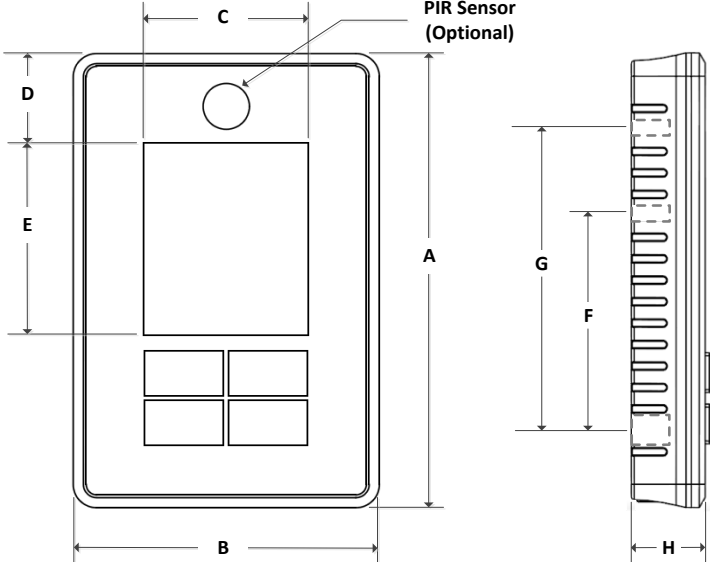

Dimensions

<p>A = 2.85"   73mm          B = 4.85"   123mm          C = 1.00"   24mm          D = 2.36"   60mm          E = 3.27"   83mm</p>	<p style="text-align: center;"><b>TRL24</b></p> 
<p>A = 5.24"   133mm          B = 2.87"   73mm          C = 3.74"   95mm          D = 1.22"   31mm          E = 0.75"   19mm          F = 2.00"   51mm          G = 2.18"   55mm</p>	<p style="text-align: center;"><b>TDU10 / TDU40 / TDU70 Series</b></p> 
<p>A = 4.88"   124mm          B = 3.25"   83mm          C = 1.75"   44mm          D = 0.96"   24mm          E = 2.07"   53mm          F = 2.36"   60mm          G = 3.28"   83mm          H = 0.78"   20mm (without CO2)          0.95"   24mm (with CO2)</p>	<p style="text-align: center;"><b>TDU00 / TDU30 / TDU60 Series</b></p> 



**TDU Models**

Horizontal Model #	Temp	RH	CO <sub>2</sub>
TDU10-100 TDU40-100 TDU70-100	•		
TDU10-101 TDU40-101 TDU70-101	•	•	
TDU10-102 TDU40-102 TDU70-102	•	•	•
TDU10-103 TDU40-103 TDU70-103	•		•



**TDU10 Series**



**TDU40 Series**



**TDU70 Series**

Vertical Model #	Temp	RH	CO <sub>2</sub>	PIR	VOC
TDU00-100 TDU30-100 TDU60-100	•				
TDU00-101 TDU30-101 TDU60-101	•	•			
TDU00-102 TDU30-102 TDU60-102	•	•	•		
TDU00-103 TDU30-103 TDU60-103	•		•		
TDU00-104 TDU30-104 TDU60-104	•			•	
TDU00-105 TDU30-105 TDU60-105	•	•		•	
TDU00-106 TDU30-106 TDU60-106	•	•	•		•
TDU00-107 TDU30-107 TDU60-107	•	•	•	•	•
TDU00-108 TDU30-108 TDU60-108	•	•	•	•	



**TDU00 Series**



**TDU30 Series**









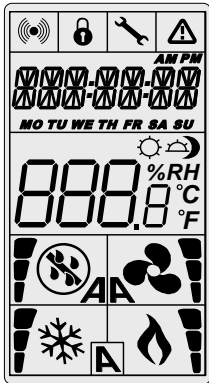

**TDU60 Series**

### Interface









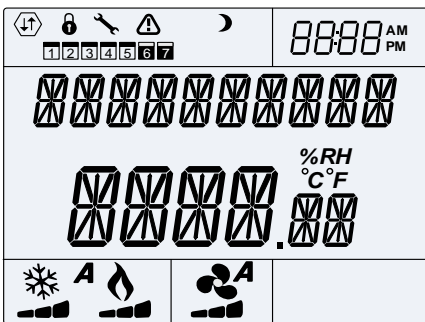



#### TRL24

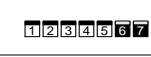

	Cooling ON A: Automatic		Communication Status		Alarm status
	Heating ON A: Automatic		Menu Locked		Energy saving mode (NSB or Occupancy)
	Fan ON A: Automatic		Programming mode (Technician setting)	<b>%RH</b>	Percentage of humidity
				<b>°C or °F</b>	°C: Celsius scale °F: Fahrenheit scale









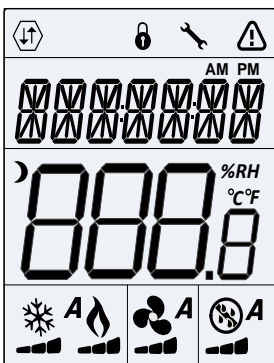

#### TDU10 / TDU40 / TDU70 Series



	Network Communication		User Lock		Programming Mode (Technician Setting)
	Alarm Status		Energy Saving Mode (NSB/OCC)		Schedule
	Time		ppm Parts Per Million		°C °C: Celsius Scale °F °F: Fahrenheit Scale %RH %RH: Humidity
	Automatic Mode		Cooling		Heating
					Fan

#### TDU00 / TDU30 / TDU60 Series



	Network Communication		User Lock		Programming Mode (Technician Setting)
	Alarm Status		Energy Saving Mode (NSB/OCC)		Time
	°C: Celsius Scale °F: Fahrenheit Scale %RH: Humidity		A Automatic Mode		Cooling
	Heating		Fan		

### Mechanical Installation - Actuator

1. Manually close the damper blades and position the actuator to 0° or 90°.
2. Slide the actuator onto the shaft.
3. Tighten the nuts on the "U" bolt to the shaft with an 8mm wrench to a torque of 60 in-lb [6.7 Nm].
4. Slide the mounting bracket under the actuator. Ensure free movement of the slot at the base of the actuator. Place the bracket pin at mid distance of the slot.
5. Affix the bracket to the ductwork with #8 self-tapping screws.



Do not press the clutch when the actuator is powered.

#### EVC with a built-in 70 in. lb. Actuator

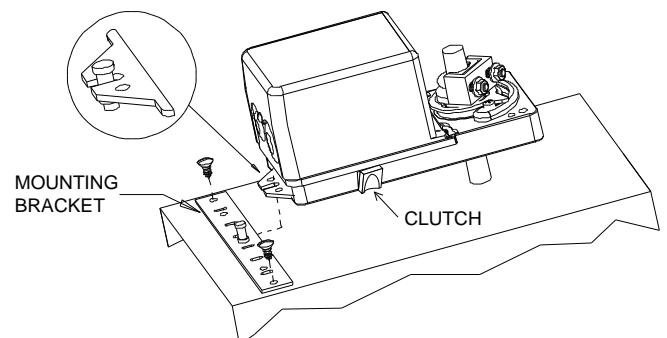

## Mounting Instructions

### TRL24

**⚠ CAUTION: Remove power to avoid a risk of malfunction.**

- Remove the captive screw that's holding the base and the front cover of the unit together.
- Lift the front cover of the unit to separate it from the base.
- Pull all wires through the holes in the base.
- Secure the base to the wall using wall anchors and screws (supplied). Make the appropriate connections.
- Mount the control module on the base and secure using the screw.

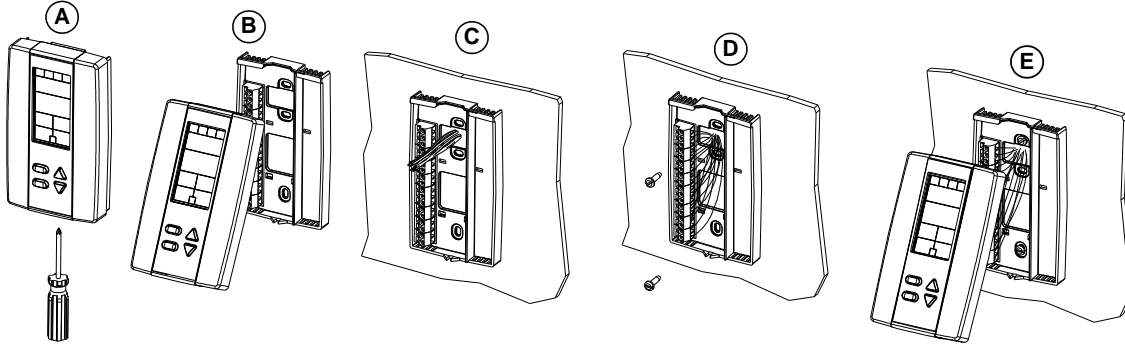

### TDU10 / TDU40 / TDU70 Series

**⚠ CAUTION: Remove power to avoid a risk of malfunction.**

- Remove the wall mounting plate (highlighted) from the back of the digital room sensor.
- Install the mounting plate on the gang box.
- Pull the wires through the base hole and make the appropriate connections.
- Mount the digital room sensor onto the wall plate. To mount it correctly, place the top of the digital room sensor on the mounting plate first and push it into the grooves to snap it into place.
- Secure the digital room sensor using the screw (supplied).

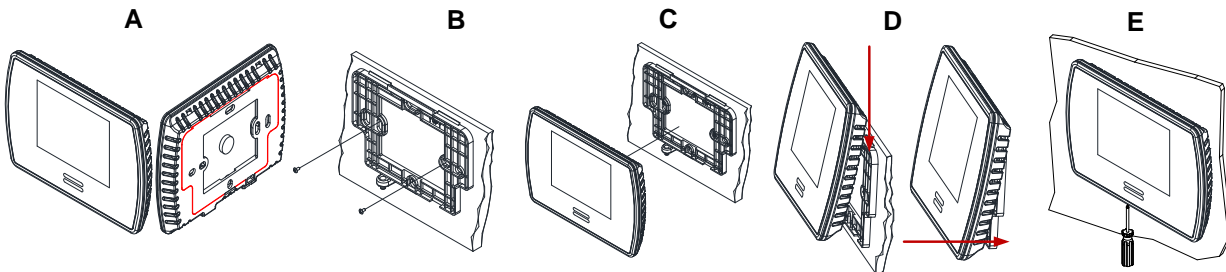

### TDU00 / TDU30 / TDU60 Series

**⚠ CAUTION: Remove power to avoid a risk of malfunction.**

- Remove the captive screw that's holding the base and the front cover of the unit together.
- Lift the front cover of the unit to separate it from the base.
- Pull all wires through the holes in the base.
- Secure the base to the wall using wall anchors and screws (supplied). Make the appropriate connections.
- Mount the control module on the base and secure using the screw.

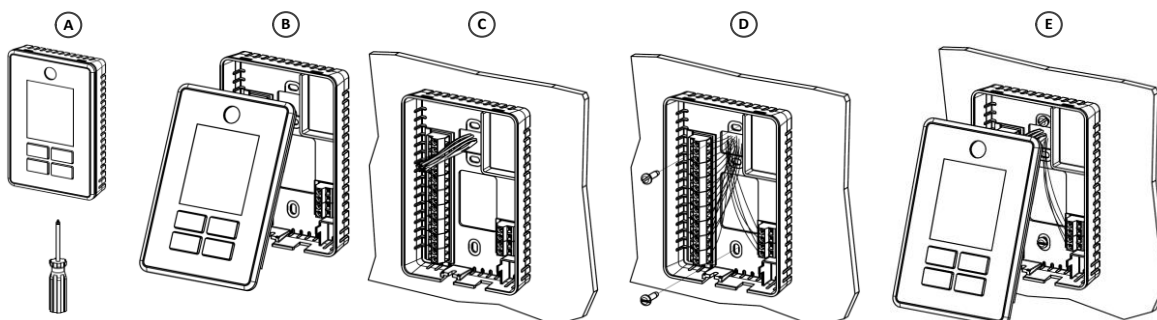



**BACnet or Modbus Address DIP Switch (DS1)**

MAC address for communication, are selectable by DIP switch using binary logic. If you do not change device instance in program mode, it will be automatically modified according to the MAC address.



*Note: Avoid using addresses above 246 when selecting Modbus MAC address.*

MAC Address	DS.1 = 1	DS.2 = 2	DS.3 = 4	DS.4 = 8	DS.5 = 16	DS.6 = 32	DS.7 = 64	DS.8 = 128	Default Device Instance
0	OFF	OFF	OFF	OFF	OFF	OFF	OFF	OFF	153000
1	ON	OFF	OFF	OFF	OFF	OFF	OFF	OFF	153001
2	OFF	ON	OFF	OFF	OFF	OFF	OFF	OFF	153002
3	ON	ON	OFF	OFF	OFF	OFF	OFF	OFF	153003
4	OFF	OFF	ON	OFF	OFF	OFF	OFF	OFF	153004
...	...	...	...	...	...	...	...	...	...
126	OFF	ON	ON	ON	ON	ON	ON	OFF	153126
127	ON	ON	ON	ON	ON	ON	ON	OFF	153127

\* Slave addresses available by setting DS.8 to ON





### Wiring

We strongly recommend that all Neptronic products be wired to a separate grounded transformer and that transformer shall service only Neptronic products. This precaution will prevent interference with, and/or possible damage to incompatible equipment.

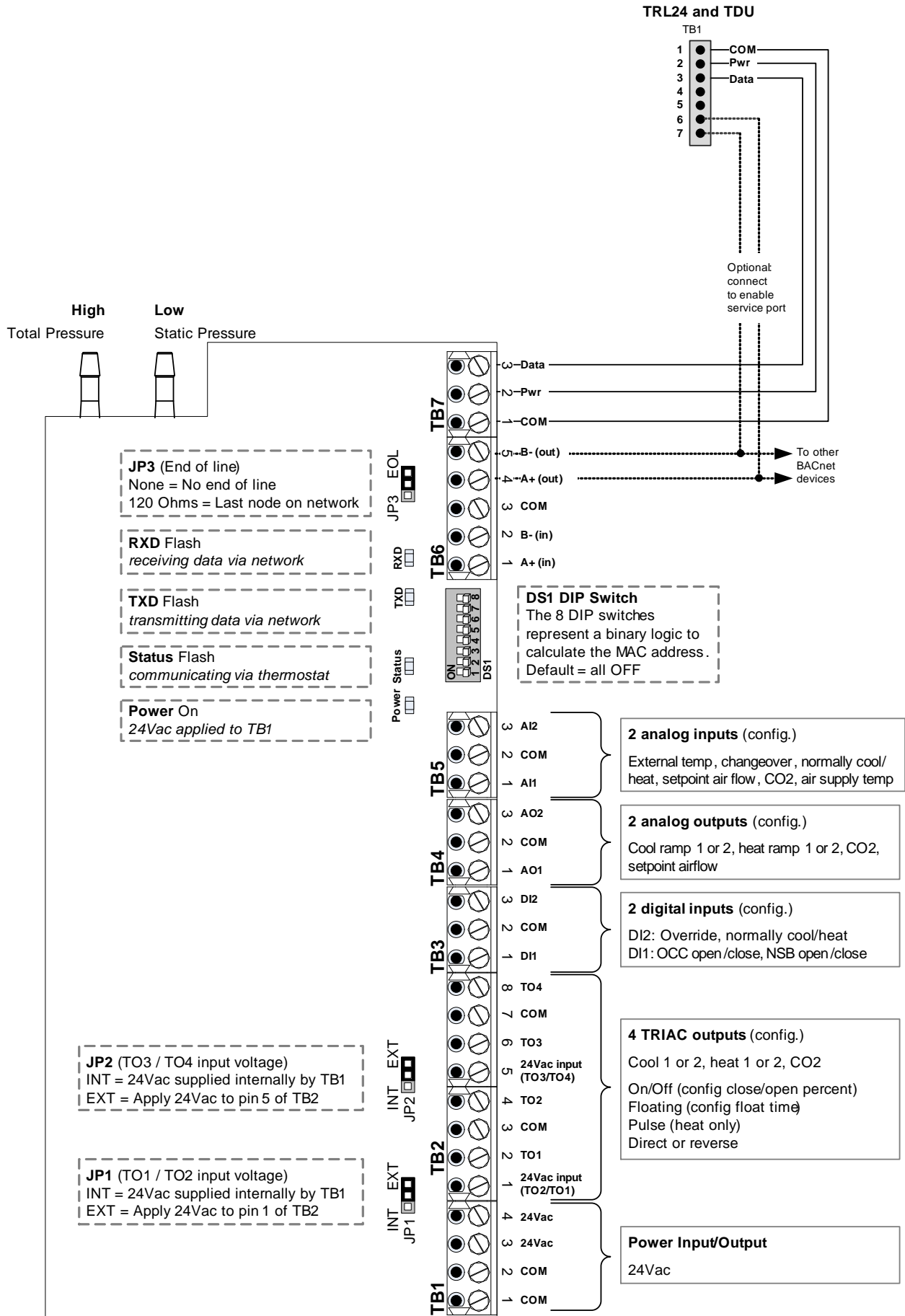

### PCB Drawings



#### TRL24 Digital Room Sensor

##### 3 wire cable (TB1 #1, 2 & 3)

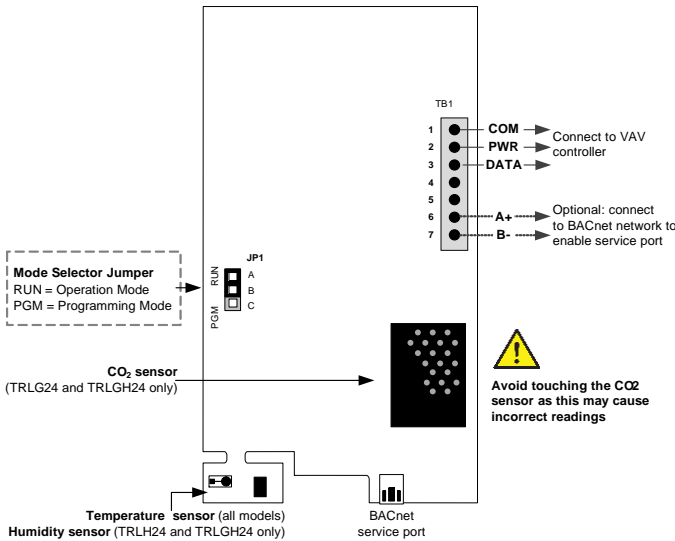
Connect TB1 #6 (A+) & #7 (B-) to EVCB to enable the BACnet service port.



#### Mode Selection (JP1)

	<p><b>RUN:</b> Digital room sensor is in <b>Operation Mode</b>. Digital room sensor must be set in this mode for normal system operation. If not locked, setpoint and control mode can be changed by the end user.</p>
	<p><b>PGM:</b> Digital room sensor is set in <b>Programming Mode</b>. Refer to the following sections for more details.</p>



#### TDU10 / TDU40 / TDU70 Series Digital Room Sensor

##### 3 wire cable (TB1 #1, 2 & 3)

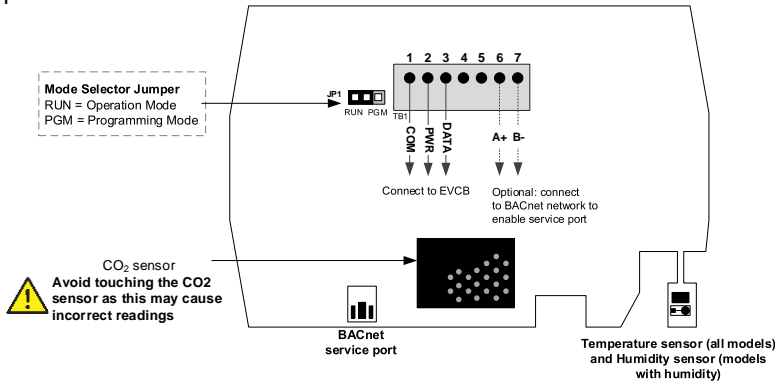
Connect TB1 #6 (A+) & #7 (B-) to EVCB to enable the BACnet service port.



#### Mode Selection (JP1)

	<p><b>RUN:</b> Digital room sensor is in <b>Operation Mode</b>. Digital room sensor must be set in this mode for normal system operation. If not locked, setpoint and control mode can be changed by the end user.</p>
	<p><b>PGM:</b> Digital room sensor is set in <b>Programming Mode</b>. Refer to the following sections for more details.</p>



#### TDU00 / TDU30 / TDU60 Series Digital Room Sensor

##### 3 wire cable (TB1 #1, 2 & 3)

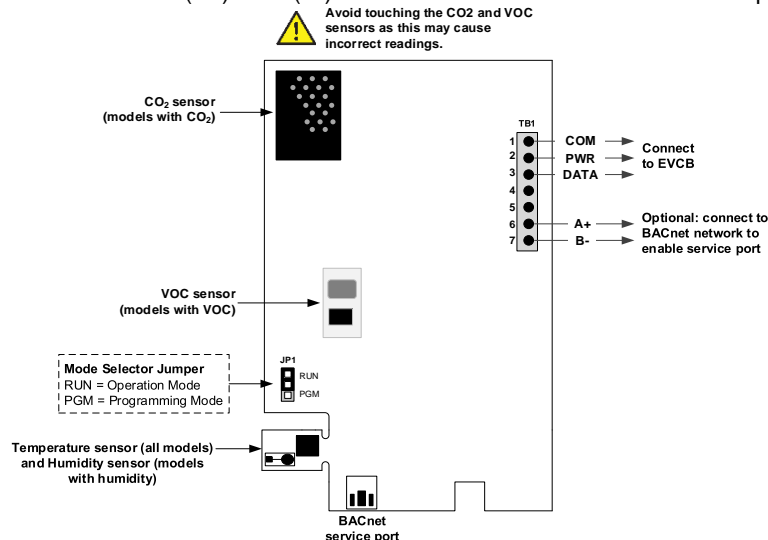
Connect TB1 #6 (A+) & #7 (B-) to EVCB to enable the BACnet service port.



#### Mode Selection (JP1)



	<p><b>RUN:</b> Digital room sensor is in <b>Operation Mode</b>. Digital room sensor must be set in this mode for normal system operation. If not locked, setpoint and control mode can be changed by the end user.</p>
	<p><b>PGM:</b> Digital room sensor is set in <b>Programming Mode</b>. Refer to the following sections for more details.</p>



## Access to Menus

The menu overviews and options are the same for both TRL24 and TDU digital room sensors. However, the action button or the button used to access the menus and save changes is different in the digital room sensors. Use the following menu overviews with the appropriate action button as per your digital room sensor.

### Action Buttons on Digital Room Sensor

Action Button		Task
TRL24	TDU	
		Press to access the programming menus and save any changes.
		Press to return to the previous step without saving.



*Note: Prior to going into Programming Mode, remove the connection cable between the EVCB and the TRL/TDU and set the Mode Selection jumper (JP1) to PGM on the digital room sensor. Reestablish the connection in order to access the programming menus and to make any changes. Once all menu changes have been made, remove the connection cable again before setting jumper JP1 back to RUN, and then reconnect the cable to resume normal operation.*

## Pressure & Applications – Menu (1 of 6) | Pressure and Applications

For a description of the default settings for each application refer to Annex A: Control Apps on page 22.

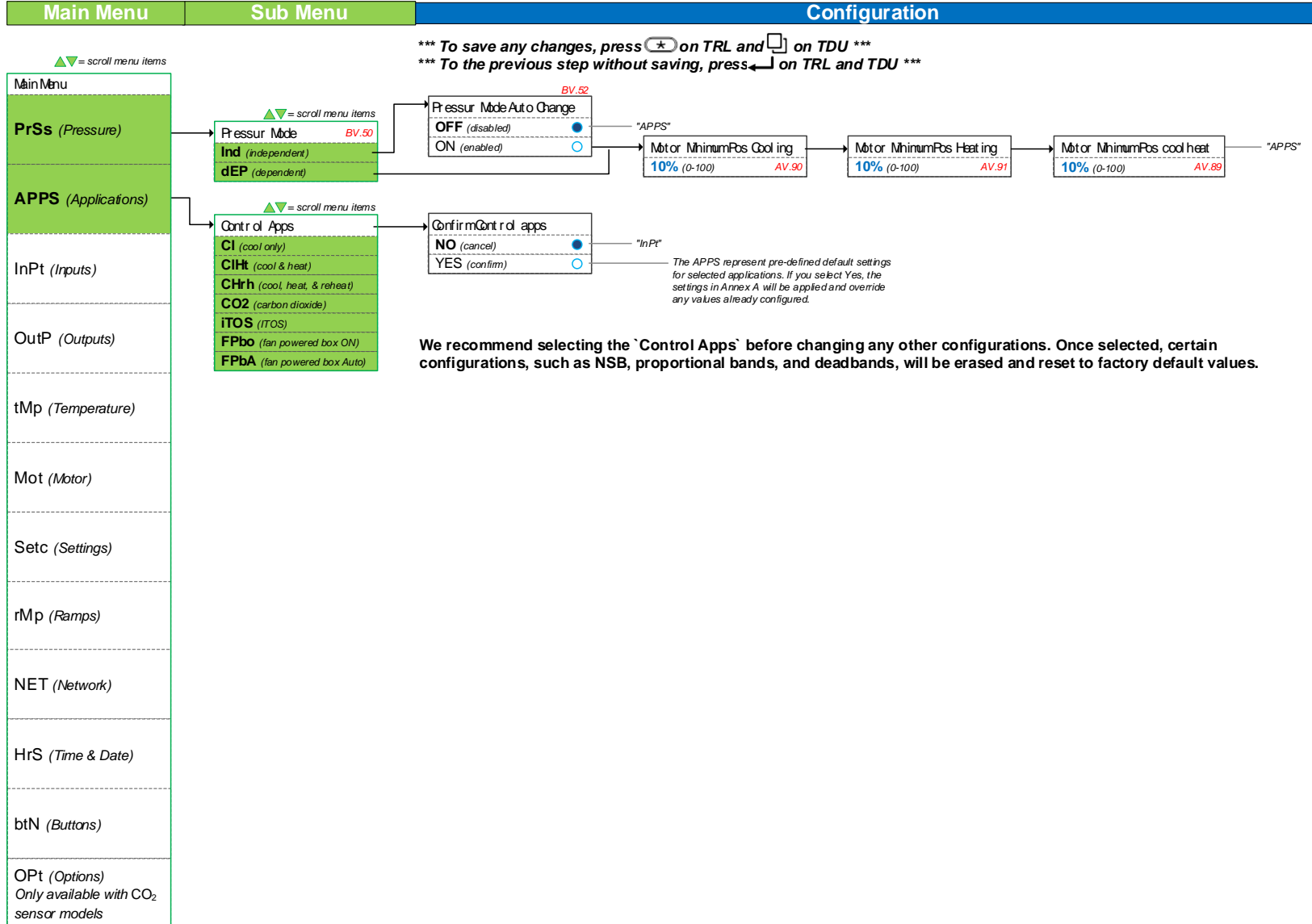

### Inputs – Menu (2 of 6) | AI1, AI2, DI1 and DI2

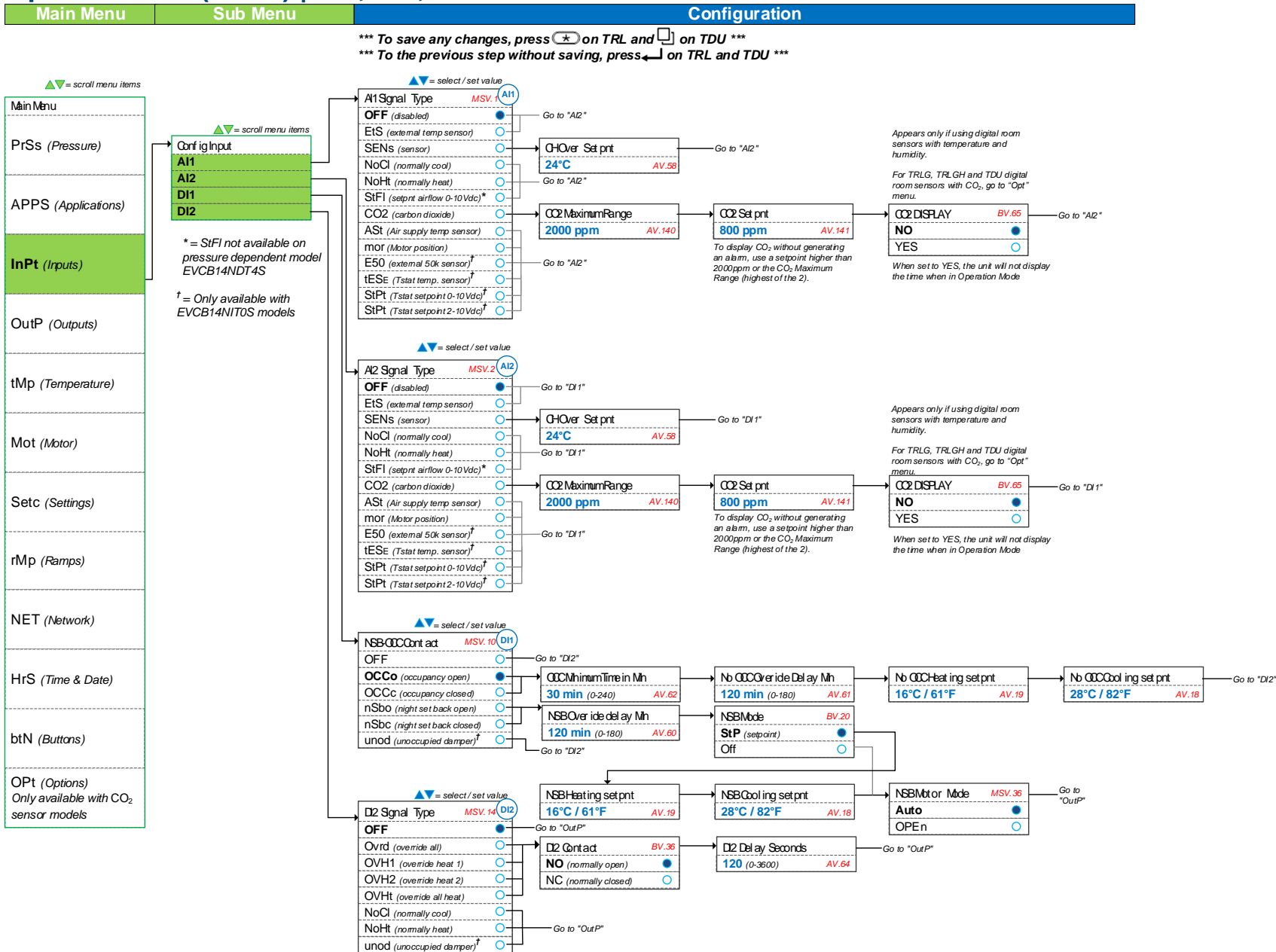

### TRIAC Outputs – Menu (3 of 6) | TO1 to TO4

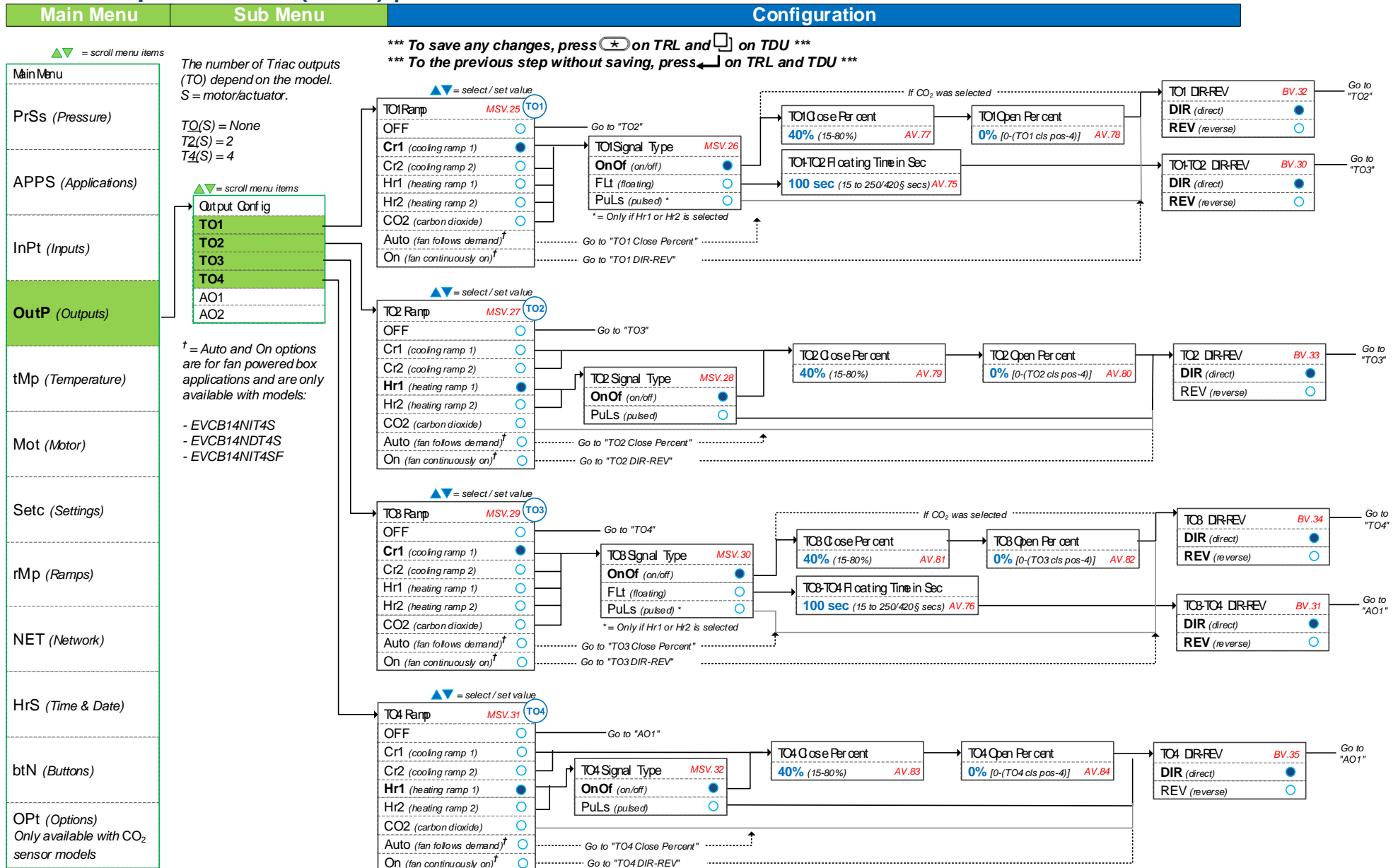

### Analog Outputs – Menu (4 of 6) | AO1 and AO2

Main Menu	Sub Menu	Configuration
-----------	----------	---------------

\*\*\* To save any changes, press **★** on TRL and **□** on TDU \*\*\*  
 \*\*\* To the previous step without saving, press **←** on TRL and TDU \*\*\*

▲▼ = scroll menu items

Main Menu
PrSs (Pressure)
APPS (Applications)
InPt (Inputs)
<b>OutP (Outputs)</b>
tMp (Temperature)
Mot (Motor)
Setc (Settings)
rMp (Ramps)
NET (Network)
HrS (Time & Date)
btN (Buttons)
OPt (Options) Only available with CO <sub>2</sub> sensor models

▲▼ = scroll menu items

Output Config
TO1
TO2
TO3
TO4
<b>AO1</b>
<b>AO2</b>

§ = For models EVCB14NIT0S, the default value is Hr1

\* = StFI not available on pressure dependent model EVCB14NDT4S

† = Auto and On options are for fan powered box applications and are only available with models:

- EVCB14NIT4S
- EVCB14NDT4S
- EVCB14NIT4SF

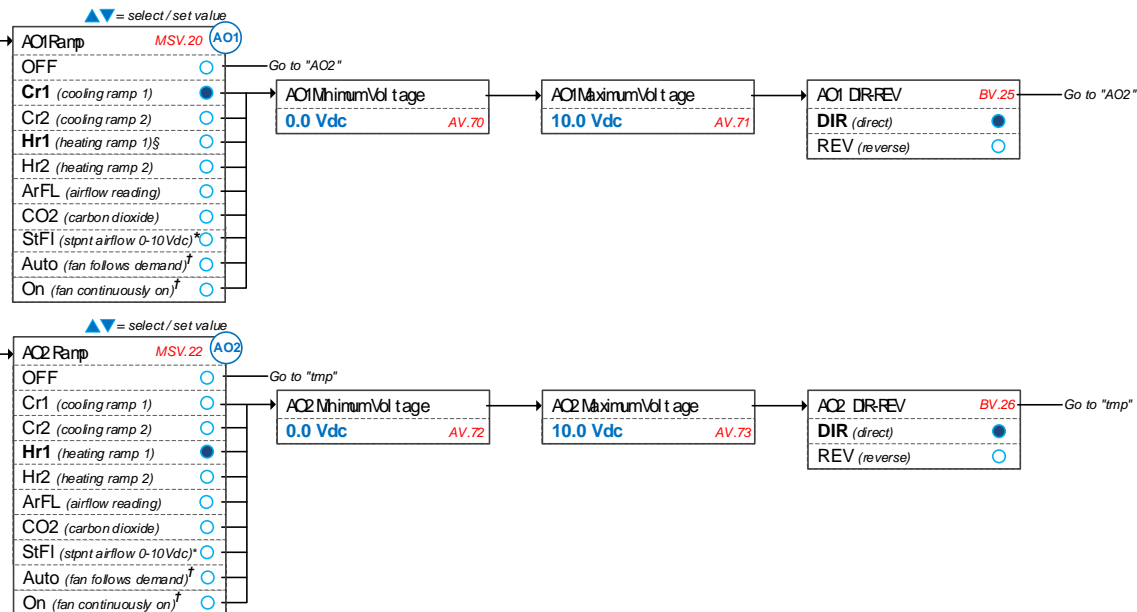

### Settings – Menu (5 of 6) | Temp, Motor, Settings and Ramps

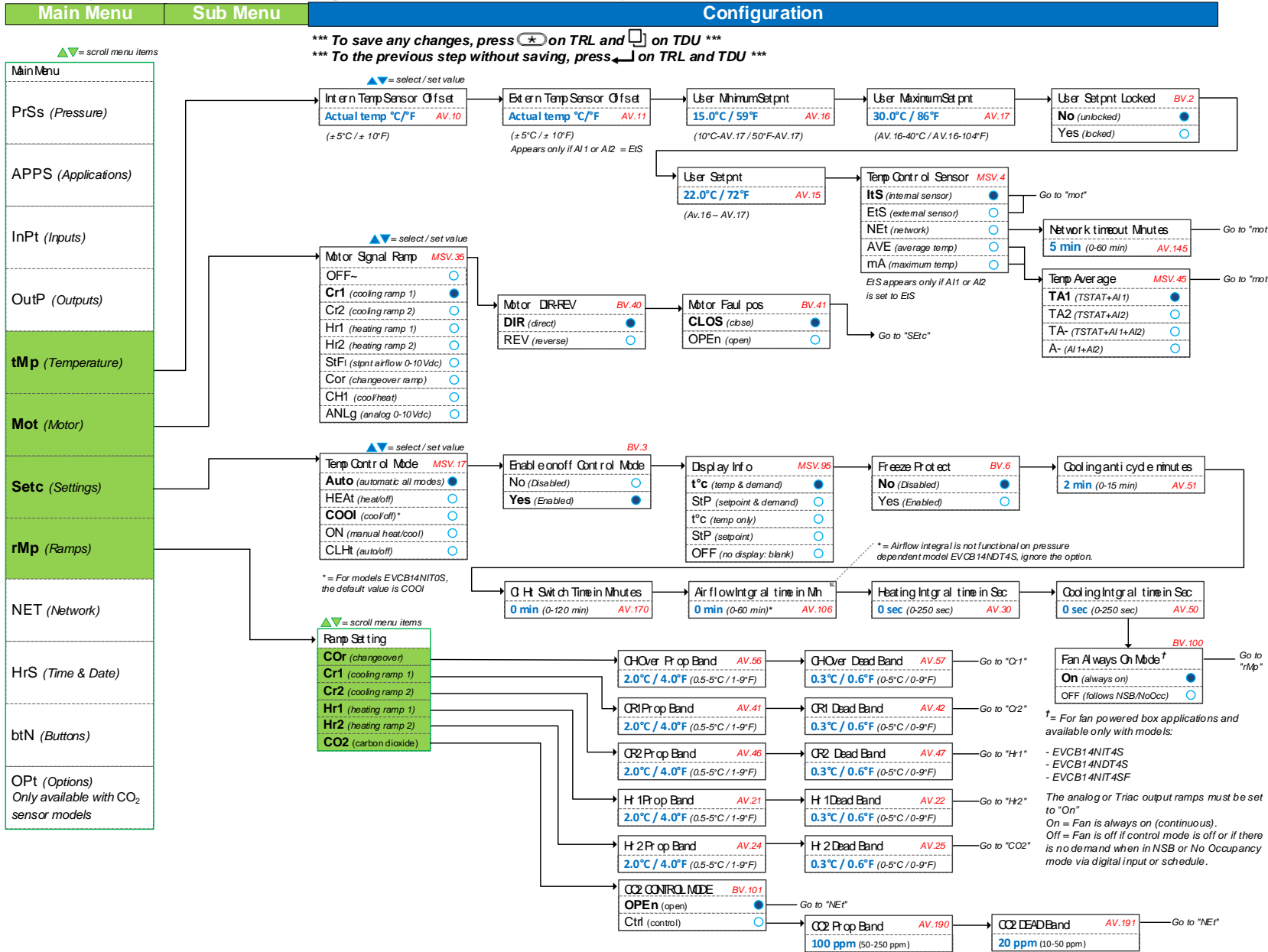



## Settings – Menu (6 of 6) | Network, Time, Buttons and Options

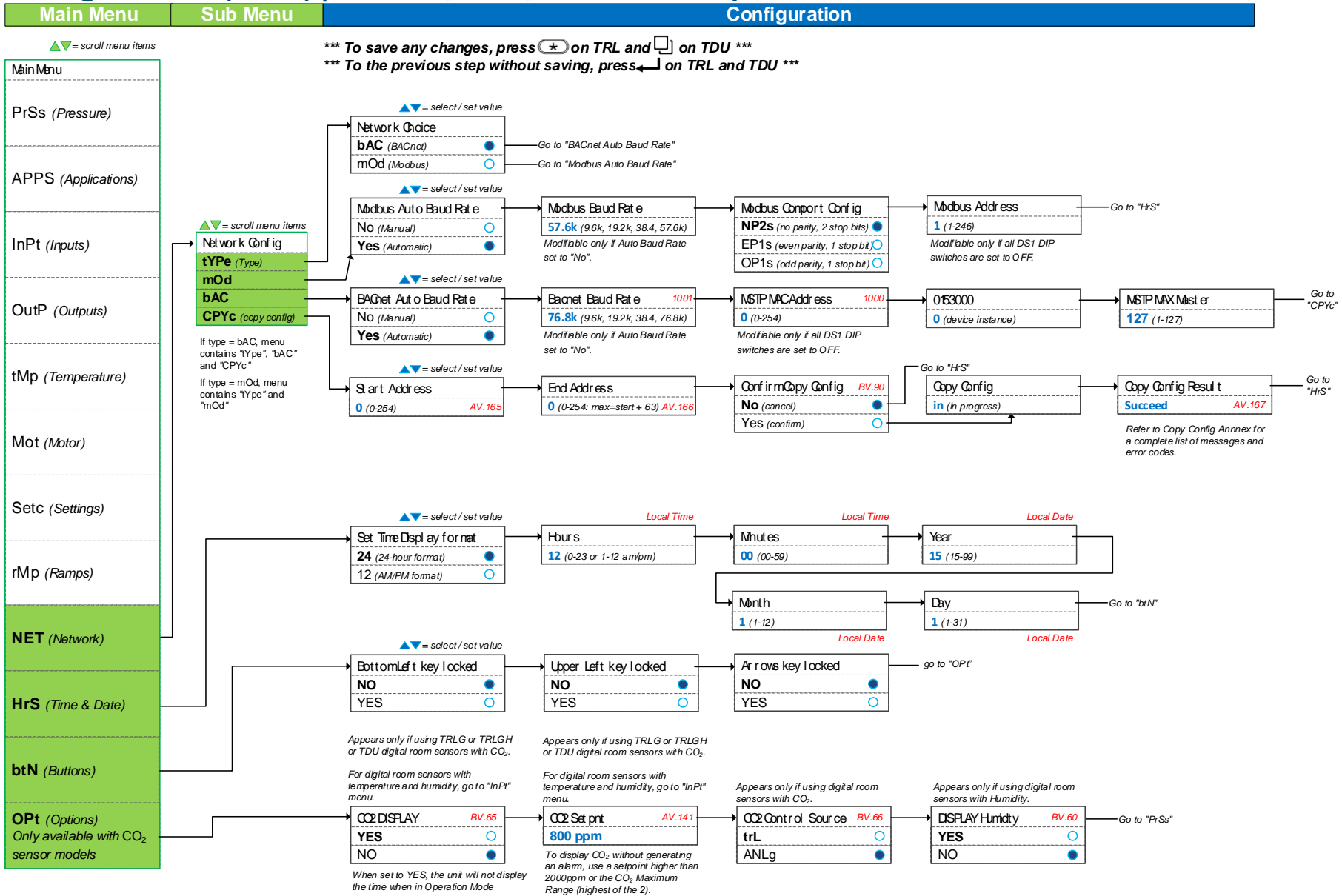

### Operation Menus

This menu is accessible through normal operation mode. The Mode Selector jumper (JP1) of the digital room sensor must be set to the "RUN" position (Operation Mode). Refer to Wiring on page 9.

Note: Since the action buttons are different on TRL and TDU digital room sensor series, both buttons have been included in the instructions. Refer to the Action Buttons on Digital Room Sensor section to know and use the button as available on your digital room sensor.

- Press the [ \* ] / [ ] and [ ← ] buttons simultaneously for 5 seconds. The "ENTER PASSWORD" screen appears.
- Enter the password within 1 minute by using the arrow keys to increase or decrease the value and the [ \* ] / [ ] and [ ← ] buttons to toggle between the digits.
  - Password **372** = Temperature Offset Menu
  - Password **637** = Network Settings Menu
  - Password **757** = Airflow Balance Mode
- If you enter the wrong password, the digital room sensor displays "Error" and returns to Operation Mode. The digital room sensor will return to normal mode if you navigate through the entire menu and do not make any selection, or if you do not press any key for 5 minutes. The changed values will be saved automatically.

### Menu 372 – Temperature Offset

#### 1. "INTERN TEMP SENSOR OFFSET"

	Range:	10 to 40°C	[50 to 104°F]
	Offset:	Max ± 5°C	
	Increment:	0.1°C	[0.2°F]

Compare the displayed temperature reading with a known value from a digital room sensor. To offset or calibrate the sensor, use the arrows key to set the desired temperature reading. This is useful for digital room sensors installed in areas where the temperature read is slightly different than the room's actual temperature. For example, a digital room sensor placed right under the air diffuser.

If the digital room sensor is set to use an external temperature sensor (EtS), the digital room sensor displays "OFF".

#### 2. "EXTERN TEMPER SENSOR OFFSET"

	Range:	0 to 50°C	[41 to 122°F]
	Offset:	Max ± 5°C	
	Increment:	0.1°C	[0.2°F]

This option appears if you've set one of the analog inputs to **EtS** (External temperature sensor). When the digital room sensor is connected to the appropriate analog input, the display shows the temperature read by the external temperature sensor. Adjust the offset by comparing it with a known value (e.g. thermometer). If the sensor is not connected or short circuited, then the unit displays the sensor's limit.

#### 3. "INPUT3 READING"

	Range:	250mV (0") to 4000mV (1")
---	--------	---------------------------

Displays the voltage output value in mV of the pressure sensor. Does not appear for EVCB14NDT4S (pressure dependent).

#### 4. "INPUT3 MINIMUM READING"

	Range:	10mV to 180mV
	Default:	60mV

This setting represents the deadband of the pressure sensor in mV. For advanced users or special applications only. We recommend that you use the default setting of 60mV. Does not appear for EVCB14NDT4S (pressure dependent) model.

### Menu 637 – Network Settings

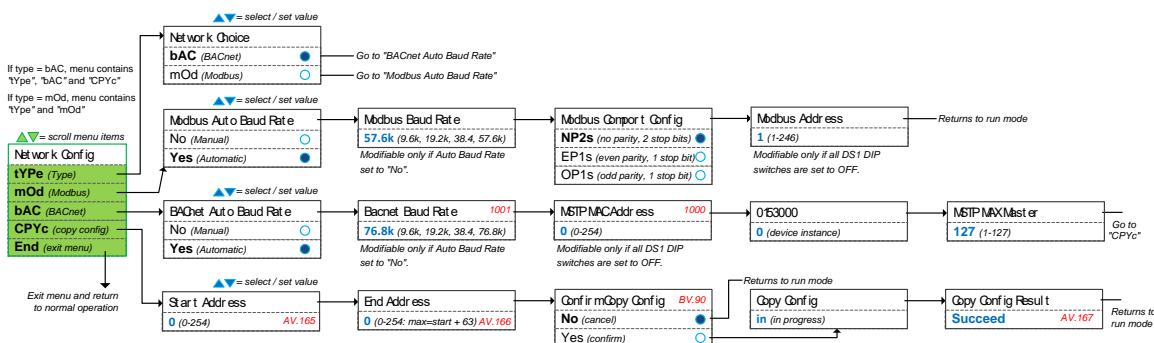

\*\*\* To save any changes, press [ \* ] on TRL and [ ] on TDU \*\*\*  
 \*\*\* To the previous step without saving, press [ ← ] on TRL and TDU \*\*\*

### Menu 757 – Airflow Balance Mode

Pressure Independent: models EVCB14NIT0S, EVCB14NIT2S, and EVCB14NIT4S

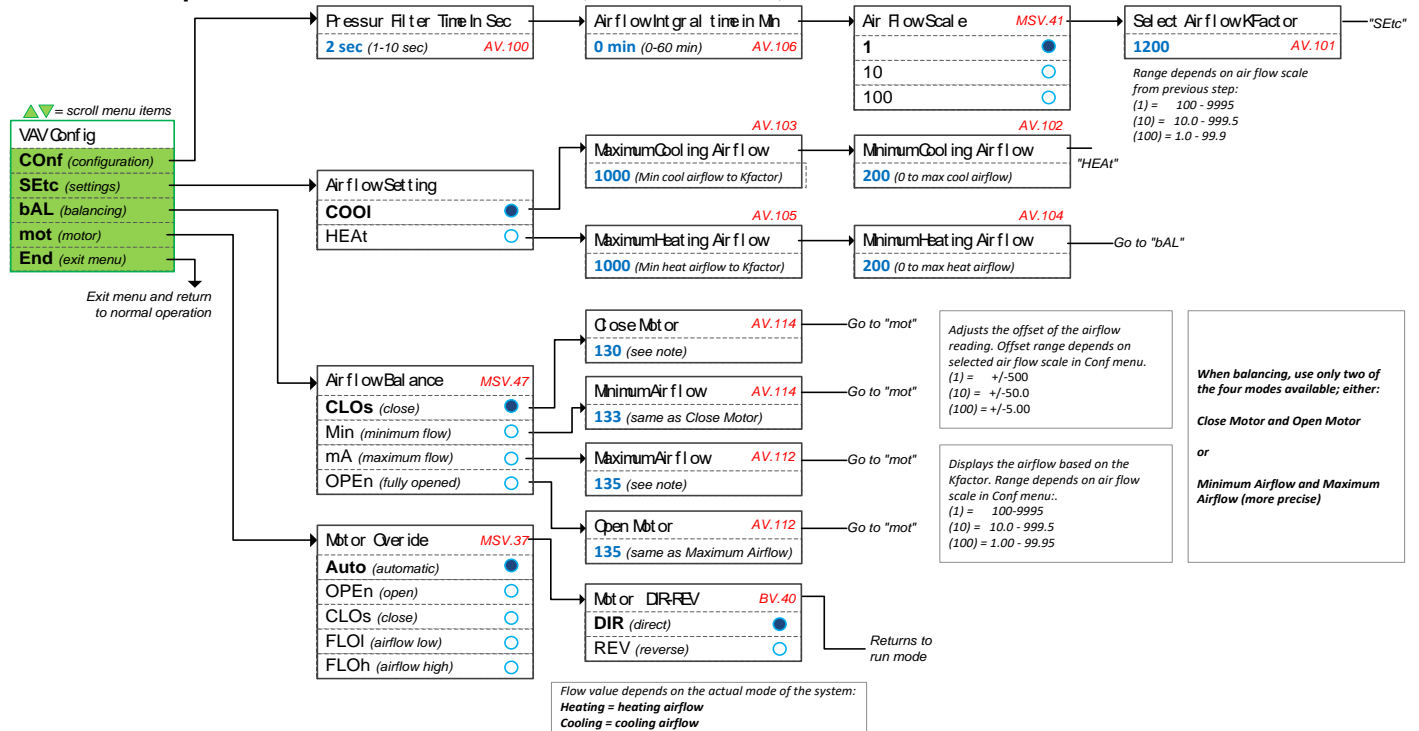

\*\*\* To save any changes, press **[\*]** on TRL and **[ ]** on TDU \*\*\*  
 \*\*\* To the previous step without saving, press **[<]** on TRL and TDU \*\*\*



Note: Refer to EVCB-Airflow Balance Instructions on Neptronic website for further information on airflow balancing function.

Pressure dependent model EVCB14NDT4S or other models if in pressure dependent mode

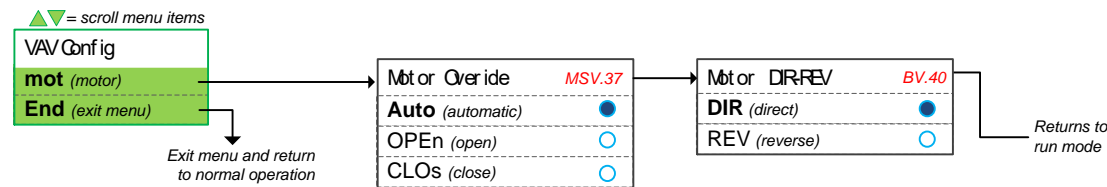

\*\*\* To save any changes, press **[\*]** on TRL and **[ ]** on TDU \*\*\*  
 \*\*\* To the previous step without saving, press **[<]** on TRL and TDU \*\*\*

### Reset to Factory Default Settings



This will erase all actual configurations and replace them with the factory default settings.

- The Mode Selector jumper (JP1) of the digital room sensor must be set to the "RUN" position (Operation Mode). Refer to Wiring on page 9.
- During the power up sequence of the controller and digital room sensor, press and hold both the **[<]** and **[v]** buttons.
- The "Enter Password" screen appears. Enter **372** within 1 minute by using the arrow keys to increase or decrease the value and the **[\*]** / **[ ]** and **[<]** buttons to toggle between the digits.
- Use the arrow buttons to select YES and then press **[\*]** / **[ ]**.

### Operation Mode

The Mode Selector Jumper (JP1) of the digital room sensor must be set to the "RUN" position (Operation Mode). Refer to Wiring on page 7.

#### TRL24

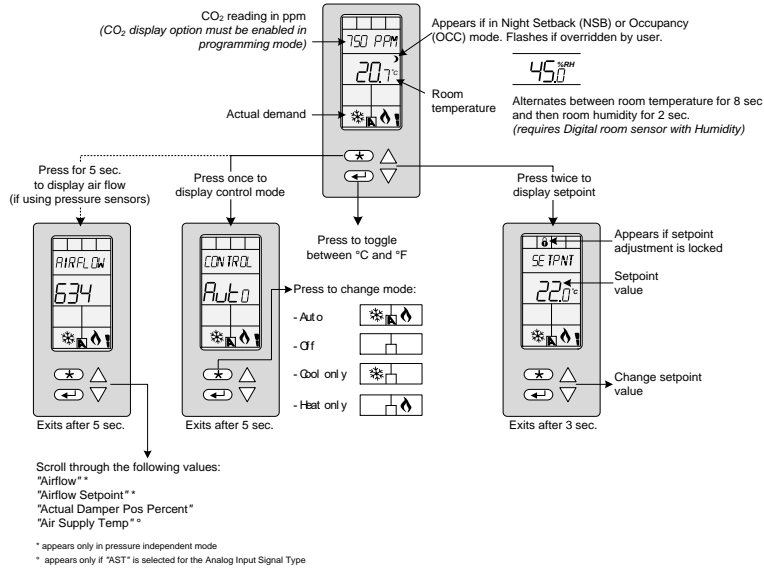

### TDU10 / TDU40 / TDU70 Series

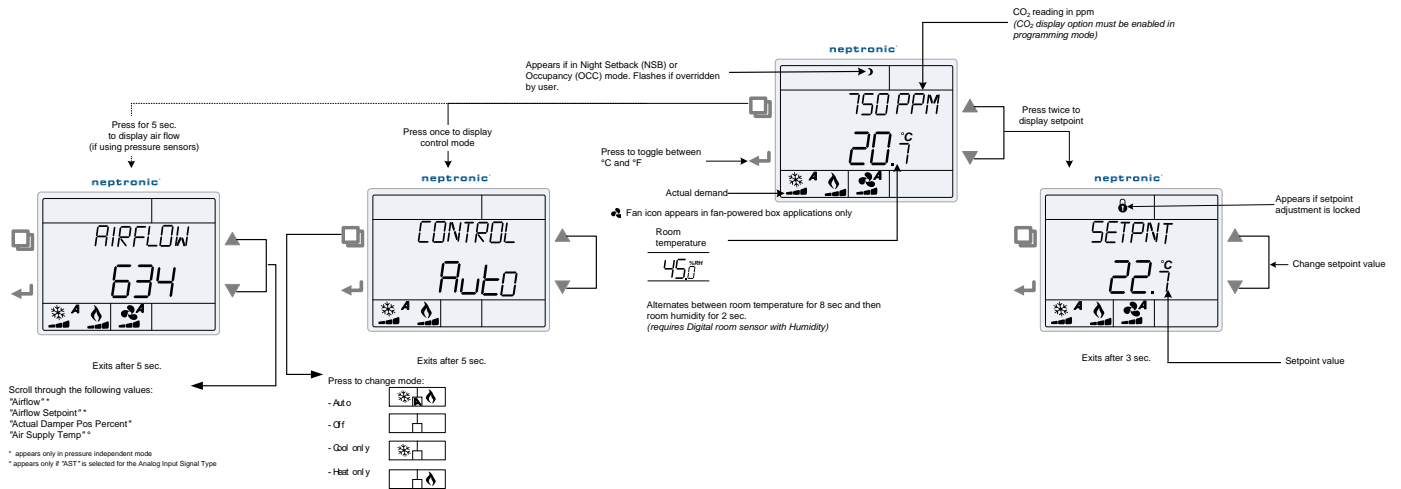

### TDU00 / TDU30 / TDU60 Series

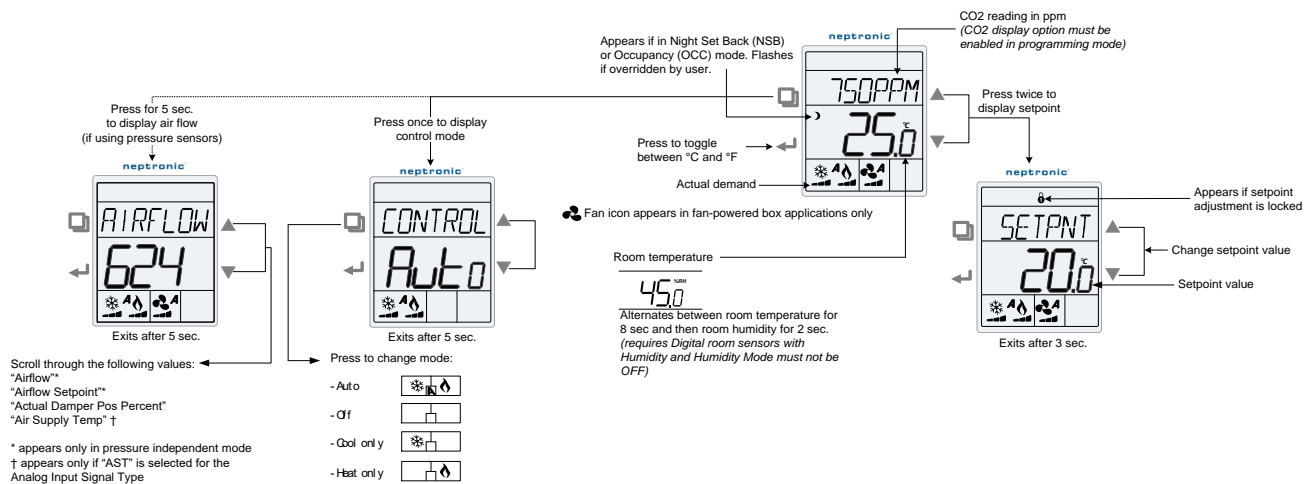

### Power Up

Upon power up, the LCD illuminates and all segments appear for 2 seconds. The digital room sensor then displays its current version of the digital room sensor for 2 seconds followed by the current version of the controller for 2 seconds. Pressing any key on the digital room sensor illuminates the LCD for 4 seconds.

### CO<sub>2</sub> (Digital Room Sensors with CO<sub>2</sub>)

If enabled via the configuration menu, the digital room sensor displays the CO<sub>2</sub> reading on the first line above the temperature reading. If CO<sub>2</sub> display is enabled, the time will not be displayed.

### Temperature Display and Setpoint

If enabled in the "Display Info" menu (see Settings – Menu (5 of 6) | *Temp, Motor, Settings and Ramps* on page 16), the digital room sensor displays the temperature reading. If the sensor is disconnected or short circuited, then the unit displays the sensor's limit. To toggle the temperature scale between °C and °F, press the  $\leftarrow$  button. To display the setpoint, press the  $\blacktriangle$  or  $\blacktriangledown$  key twice. The setpoint appears for 5 seconds. To adjust the setpoint, press the arrow keys while the temperature is displayed. If the setpoint adjustment has been locked "Setpnt Locked", the lock  $\mathcal{L}$  symbol appears.

### Humidity

If enabled in the "Options" menu (see Settings – Menu (6 of 6) | *Network, Time, Buttons and Options* on page 17), the digital room sensor displays the temperature reading for 8 seconds and then displays the humidity reading for 2 seconds. If the sensor is disconnected or short circuited, then the unit displays the sensor's limit.

### Airflow and Air Supply Temperature

Press and hold the  $\left[\star\right] / \left[\square\right]$  button for 5 seconds and use the arrow keys to view the "AIRFLOW", "AIRFLOW SETPNT", "actual damper pos percent" and "air Supply Temp". After 5 seconds without any action, the digital room sensor returns to operation mode. The air supply temperature appears only if analog input AI1 or AI2 are configured with the AST option. Not available on the following pressure dependent model *EVCB14NDT4S*.

### Control Mode

To access the Control Mode, press the  $\left[\star\right] / \left[\square\right]$  button. The Control Mode appears for 5 seconds. Press the  $\left[\star\right] / \left[\square\right]$  button to scroll through the following control modes. These options can vary depending on the options selected in "Temp Control Mode" and "Enable OnOff Control Mode".

- Auto (Automatic Cooling or Heating)
- OFF (if it is not disabled in Programming Mode)
- Cooling only (on, with cooling symbol)
- Heating only (on, with heating symbol)

### Night Setback (NSB) or Occupancy Mode

This function is only available if you set DI1 to **nSb** (Night setback contact) or **Occ** (occupancy mode). If the DI1 contact is triggered, the digital room sensor enters NSB or No Occupancy Mode (the  $\rightarrow$  symbol appears) and uses the NSB or OCC heating and cooling setpoints.

If not locked, you can override the night setback or no occupancy mode for a predetermined period by pressing any of the 4 buttons. During the override period the  $\rightarrow$  symbol will flash. If the  $\rightarrow$  symbol does not flash, the override period is finished or the night setback or no occupancy override has been locked in programming mode.

### Set Time and Date

1. Ensure that JP1 on the digital room sensor is set to run.
2. Press and hold the  $\leftarrow$  button for 5 seconds
3. Use the arrow keys to set the desired value. Press the  $\left[\star\right] / \left[\square\right]$  button to save and got to the next step. Press the  $\leftarrow$  button to go to the previous step without saving.

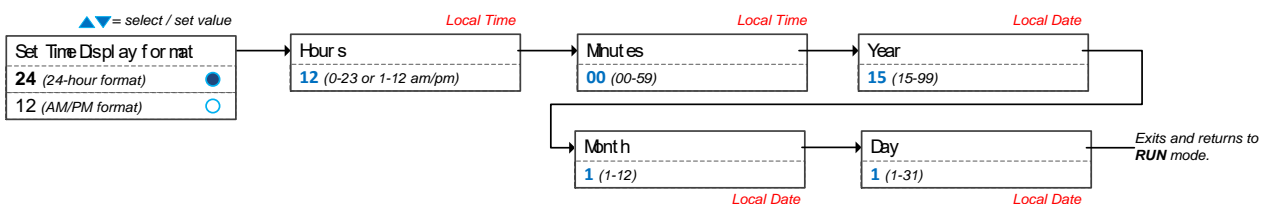

\*\*\* To save any changes, press  $\left[\star\right]$  on TRL and  $\left[\square\right]$  on TDU \*\*\*

\*\*\* To the previous step without saving, press  $\leftarrow$  on TRL and TDU \*\*\*

Note: Time will only be displayed on the TDU when the Bacnet scheduler is active. In order to achieve this, set the proper BACnet Object present value to Yes (1): *EVCB BV.70 – Cfg\_ActiveSchedule*.



### Annex A: Control Apps

Refer to *Pressure & Applications – Menu (1 of 6)* on page 12 for more information. The available **Control Apps** vary according to the model.

Description	CL (cool only)	CLHt (cool/heat)	CHrH (cool/heat/reheat)	CO <sub>2</sub> (CO <sub>2</sub> )	ITOS (ITOS)	FPbo (fan powered ON)	FPbA (fan powered Auto)
Min. Setpoint	<b>20°C (68°F)</b>	<b>20°C (68°F)</b>	<b>20°C (68°F)</b>	<b>20°C (68°F)</b>	15°C (59°F)	15°C (59°F)	15°C (59°F)
Max. Setpoint	<b>28°C (82°F)</b>	<b>28°C (82°F)</b>	<b>28°C (82°F)</b>	<b>28°C (82°F)</b>	30°C (86°F)	30°C (86°F)	30°C (86°F)
Changeover Setpnt	24°C (75°F)	<b>20°C (68°F)</b>	<b>20°C (68°F)</b>	<b>20°C (68°F)</b>	24°C (75°F)	24°C (75°F)	24°C (75°F)
TO1 Ramp	<b>HR1</b>	CR1	<b>HR1</b>	CR1	<b>OFF</b>	<b>HR1</b>	<b>HR1</b>
TO1 Signal Type	On/Off	On/Off	On/Off	On/Off	On/Off	On/Off	On/Off
TO1 Close Pos.	40%	40%	40%	40%	40%	<b>35%</b>	<b>35%</b>
TO1 Open Pos.	0%	0%	0%	0%	0%	0%	0%
TO2 Ramp	HR1	HR1	HR1	<b>CO<sub>2</sub></b>	<b>OFF</b>	HR1	HR1
TO2 Signal Type	<b>Pulse</b>	On/Off	<b>Pulse</b>	On/Off	On/Off	On/Off	On/Off
TO2 Close Pos.	40%	40%	40%	40%	40%	<b>70%</b>	<b>70%</b>
TO2 Open Pos.	0%	0%	0%	0%	0%	<b>35%</b>	<b>35%</b>
TO3 Ramp	<b>HR2</b>	<b>CR2</b>	<b>HR2</b>	<b>HR1</b>	<b>OFF</b>	<b>Fan ON</b>	<b>Fan Auto</b>
TO3 Signal Type	On/Off	On/Off	On/Off	On/Off	On/Off	On/Off	On/Off
TO3 Close Pos.	40%	40%	40%	40%	40%	40%	40%
TO3 Open Pos.	0%	0%	0%	0%	0%	0%	0%
TO4 Ramp	<b>HR2</b>	<b>HR2</b>	<b>HR2</b>	<b>HR1</b>	<b>OFF</b>	<b>HR1</b>	<b>HR1</b>
TO4 Signal Type	<b>Pulse</b>	On/Off	<b>Pulse</b>	On/Off	On/Off	On/Off	On/Off
TO4 Close Pos.	40%	40%	40%	40%	40%	40%	40%
TO4 Open Pos.	0%	0%	0%	0%	0%	0%	0%
Motor Ramp	CR1	<b>CO<sub>r</sub></b>	<b>CO<sub>r</sub></b>	<b>CO<sub>r</sub></b>	CR1	CR1	<b>CO<sub>r</sub></b>
AO1 ramp	<b>HR1</b>	CR1	<b>HR1</b>	CR1	<b>HR1</b>	<b>HR1</b>	<b>HR1</b>
AO2 Ramp	<b>HR2</b>	HR1	<b>HR2</b>	HR1	<b>OFF</b>	<b>HR2</b>	<b>Fan Auto</b>
AI1 Input	OFF	<b>SENS</b>	<b>SENS</b>	<b>SENS</b>	OFF	OFF	<b>SENS</b>
AI2 Input	OFF	OFF	OFF	<b>CO<sub>2</sub></b>	OFF	OFF	OFF
DI1 Input	<b>nSb.o</b>	<b>nSb.o</b>	<b>nSb.o</b>	Occ.o	Occ.o	<b>nSb.o</b>	<b>nSb.o</b>
Heat Prop Band 2	2°C (4°F)	2°C (4°F)	2°C (4°F)	2°C (4°F)	2°C (4°F)	<b>1°C (2°F)</b>	<b>1°C (2°F)</b>
Heat Deadband 2	<b>1.3°C (2.6°F)</b>	<b>1.3°C (2.6°F)</b>	<b>1.3°C (2.6°F)</b>	<b>1.3°C (2.6°F)</b>	0.3°C (0.6°F)	<b>1.3°C (2.6°F)</b>	<b>1.3°C (2.6°F)</b>
Cool Deadband 2	<b>1.3°C (2.6°F)</b>	<b>1.3°C (2.6°F)</b>	<b>1.3°C (2.6°F)</b>	<b>1.3°C (2.6°F)</b>	0.3°C (0.6°F)	0.3°C (0.6°F)	0.3°C (0.6°F)

### Legend

Grey Text = Standard default value

**Bold Text** = Special default value for selected application

- HR = Heating ramp
- CR = Cooling ramp
- CO<sub>r</sub> = Changeover ramp
- SENS = Changeover temperature sensor
- Fan ON = Fan powered box in continuous mode
- Fan Auto = Fan powered box in automatic mode (follows demand)
- nSb.o = Night Setback (normally open)
- Occ.o = Occupancy mode (normally open)
  
- TO = TRIAC output
- AO = Analog output
- AI = Analog input
- DI = Digital input





Recycling at end of life: please return this product to your Nepronic local distributor for recycling. If you need to find the nearest Nepronic authorized distributor, please consult [www.nepronic.com](http://www.nepronic.com).



**nepronic®**

400 Lebeau blvd, Montreal, Qc, H4N 1R6, Canada

[www.nepronic.com](http://www.nepronic.com)

Toll free in North America: 1-800-361-2308

Tel.: (514) 333-1433

Fax: (514) 333-3163

Customer service fax: (514) 333-1091

Monday to Friday: 8:00am to 5:00pm (Eastern time)